

iStr!x

2022-1



# iStr!x



**iStr!x** bvba

Oudenaardsesteenweg 397

8581 Avelgem

Tel: 0472/663442

: 056/754802

email: [info@iStrix.be](mailto:info@iStrix.be)

website: [www.iStrix.be](http://www.iStrix.be)

**Zaakvoerders :** Vercruyse Chris  
Deboscher Rita

**Commerciële afgevaardigden :**

*Vlaanderen :*

**Dhr Annick Vanfleteren**

**0468/49 68 16**

[annick@istrix.be](mailto:annick@istrix.be)

*Wallonië :*

**Dhr Paquay Pierre**

**0468/46 27 80**

[Pierre@istrix.be](mailto:Pierre@istrix.be)





# Inhoudstafel - Contenu

Escabeau / ladders

Echaufadages - stellingen

Bac à mortier - mortelkuipen en emmers en tubs

étau de maçon / metserschoor

Duimstok ploimeters - mètre pliant

Adhesive tapes / tapes

Paint spray-verfspuitbussen-peinture

Cellfast tuin - jardin

Kruiwagen-brouette + gieters / arrosoirs

Muggengaas - Mosquito net



**vermelde brutoprijzen zijn enkel indicatief !**

les prix brut sont seulement indicatifs

**Prijswijzigingen steeds mogelijk zonder voorafgaand bericht./**

Les prix sont susceptibles d'être modifiés sans préavis.

**Deze prijslijst vernietigt alle voorgaande./**

Cette liste annule toutes les précédentes.

**iStr!x**

## Ladders - échelles + stellingen-échaufadages



## Basic trapladders - échelles



4 steps

F232150	4st	2 TREDEN - 2 STEPS	44x53x77 cm	€ 48,95
F232155	4st	3 TREDEN - 3 STEPS	45x73x102 cm	€ 71,34
F232160	3st	4 TREDEN - 4 STEPS	45x85x125 cm	€ 88,46

## Comfort huishoudladders - échelles



F232145	4 pcs	2 steps hoogte - hauteur 81cm	€ 84,59
F232146	4 pcs	3 steps hoogte - hauteur 84cm	€ 106.65
F232147	4 pcs	4 steps hoogte - hauteur 136 cm	€ 140.74



**EN-131**

# ESCA BO

HOUSEHOLD ALUMINIUM LADDERS 150 KG

**professional and home use**

EN-131 approved  
Made in Europe

PRIX-PRIJS  
/pc mix

ES1502 2 steps



57.70



ES1503 3 steps



70.86



ES1504 4 steps



80.20



ES1505 5 steps



90.69



ES1506 6 steps



114.40



ES1507 7 steps



146.00



ES1508 8 steps



178.50





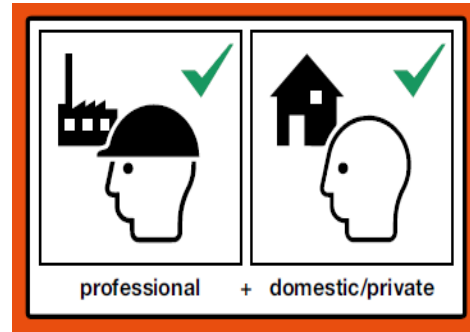

iStr!x



Modèle / Type / Leitertyp	ES1502	ES1503	ES1504	ES1505	ES1506	ES1507	ES1508
Nombre de marches Aantal treden Stufenzahl	2	3	4	5	6	7	8
A	1120	1250	1480	1710	1940	2170	2400
B	390	405	428	452	476	500	524
C	440	570	780	1000	1215	1430	1650
D	1050	1180	1390	1600	1825	2040	2260
V	2440	2560	2780	2990	3210	3420	3640
[kg]	3,2	3,45	4,15	4,65	5,45	6,2	6,75

# EN-131



Classification					
 professional	 + domestic/private	<b>Professional use – for professionals</b> → ladders for commercial as well as private use		 domestic/private	<b>Domestic use – only non-professional</b> → for ladders only to be used in the domestic area
<b>Fatigue strength test for standing step ladders:</b> Repetition cycle: 50.000 cycles <b>Strength test:</b> Proof load: 2.700 N (approx. 275 kg)		<b>Fatigue strength test for standing step ladders:</b> Repetition cycle: 10.000 cycles <b>Strength test:</b> Proof load: 2.250 N (approx. 229 kg)			

Domestic use = home thuisgebruik = 10.000 cycli

*Usage domestique = 10 000 cycles*

Professioneel gebruik = 50.000 cycli = 5 x meer dan ladders alleen voor thuis home-gebruik

*Usage professionnel = 50 000 cycles = 5 x plus que les échelles à usage domestique uniquement*

KRAUSE is een topmerk en al onze producten worden geproduceerd volgens de momenteel geldende normen / NORM, zoals EN 14183, 131, 1004, etc.

*KRAUSE est une marque de premier plan et tous nos produits sont fabriqués conformément aux normes / NORM actuellement applicables, telles que EN 14183, 131, 1004, etc.*

Daarom produceert KRAUSE geen low budget producten zonder EN-normen met lagere max. gewicht - laden.

*Par conséquent, KRAUSE ne fabrique pas de produits à petit budget sans normes EN avec un poids maximum inférieur.*

Bij een ongeval zijn nog steeds de EN-normen de basis.

*En cas d'accident, les EN-normes restent la base.*

Elke productverzekering dekt alleen producten die zijn geproduceerd volgens de momenteel geldende normen en voor al onze klanten zijn dit de richtlijnen.

*Toute assurance produit ne couvre que les produits fabriqués selon les normes en vigueur et ce sont les lignes directrices pour tous nos clients.*

Met de implementatie van de twee klassen "professioneel" en "niet-professioneel", hebben we een algemene bedrijfsbeslissing genomen om al onze producten te produceren met de classificatie "professioneel".

*Avec la mise en place des deux classes "professionnel" et "non professionnel", nous avons pris une décision commerciale générale de fabriquer tous nos produits avec la classification "professionnelle".*

## Accessoires alu trapladders

2 pcs on blistercard packed

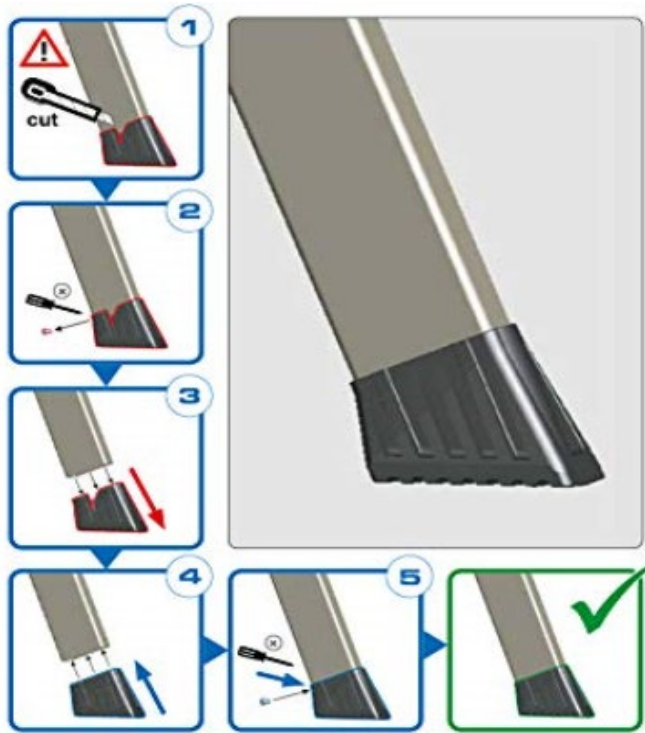

211415

voetjes trapladder - pieds échelles  
"vooraan gebruik - utilisation devant"  
2cm - 3,3cm

4009199211415

12,43 €



211422

voetjes trapladder - pieds échelles  
"achteraan gebruik - utilisation arrière"  
2cm -4cm

4009199211422

14,34 €



## PROFESIONAL STEPLADDER ONE SIDE STEPS



K-1503	“STABILO Professional” Standing Step Ladder 3 steps	€ 332,84
K-1504	“STABILO Professional” Standing Step Ladder 4 steps	€ 367,50
K-1505	“STABILO Professional” Standing Step Ladder 5 steps	€ 398,69
K-1506	“STABILO Professional” Standing Step Ladder 6 steps	€ 445,00
K-1507	“STABILO Professional” Standing Step Ladder 7 steps	€ 554,40
K-1508	“STABILO Professional” Standing Step Ladder 8 steps	€ 609,50
K-1510	“STABILO Professional” Standing Step Ladder 10 steps	€ 742,70
K-1512	“STABILO Professional” Standing Step Ladder 12 steps	€ 873,50

Number of steps			1x4	1x5	1x6	1x7	1x8	1x10	1x12
	A up to approx.	in m	2,95	3,20	3,40	3,65	3,90	4,35	4,80
	B up to approx.	in m	0,95	1,20	1,40	1,65	1,90	2,35	2,80
	C up to approx.	in m	1,70	1,95	2,20	2,45	2,70	3,20	3,70
	D up to approx.	in m	1,60	1,80	2,05	2,30	2,50	3,00	3,45
Floor area approx.		in m	0.89 x 0.50	1.04 x 0.53	1.20 x 0.56	1.34 x 0.58	1.50 x 0.61	1.81 x 0.67	2.11 x 0.73
Product weight approx.		in kg	6.4	7.3	8.4	9.5	10.5	13.0	15.6
	Width (B) approx.	in m	0.50	0.53	0.56	0.58	0.61	0.67	0.73
	Depth (T) approx.	in m	0.17	0.17	0.17	0.17	0.17	0.17	0.17
	Length (L) approx.	in m	1.75	2.00	2.25	2.50	2.75	3.25	3.75

**EN-131**

## Product highlights



+ High safety top rail with screwed-on tool tray and integrated bucket hook



+ Sturdy aluminium safety platform made of extruded profile with slip-resistant surface and platform lifters on both sides



+ High-strength braced step/side rail connection



+ Two-component foot caps **SafetyCap** for a safe stand



Hoge veiligheidsbovenrail met opgeschroefde gereedschapsbak en geïntegreerde emmerhaak

*Rail supérieur haute sécurité avec plateau à outils à visser et crochet seau intégré*

Stabiele, railomsluitende, opgeschroefde hightech metalen scharnierverbinding

*Fixation de charnière métallique high-tech stable, fermant le rail*

Geïntegreerde blokkeringsbeveiliging door eindkap van veiligheidsrail

*Protection de blocage intégrée grâce à l'embout du rail de sécurité*

Stevig aluminium veiligheidsplatform van geëxtrudeerd profiel met antislip oppervlakte- en platformheffers aan beide zijden

*Plate-forme de sécurité en aluminium robuste en profilé extrudé avec antidérapant*

*élévateurs de surface et de plate-forme des deux côtés*

Weerbestendige geschroefde banden genaaid in metalen clips voor versie 6-stappen en hoger

*Sangles boulonnées résistantes aux intempéries cousues dans des clips métalliques pour la version 6 marches et plus*

Zeer sterke versterkte opstap/zijhekverbinding

*Connexion marche/rail latéral renforcée très solide*

Twee componenten voetdoppen (SafetyCap) voor een veilige stand

*Embouts de pied à deux composants (SafetyCap) pour un support sécurisé*

Extra hoekversterking bij de onderste trede voor meer stabiliteit

*Renfort d'angle supplémentaire au bas de la marche pour plus de stabilité*

**PROFESSIONELE REFORM - SCHUIFLADDERS ALU**  
**ECHELLES COULISSANTES- TRANSFORMABLES ALU**

2XR8	2 x 8 treden/échelons	4009199032089	€ 210.46
2R11	2 x 11 treden/échelons	4009199032119	€ 275.90

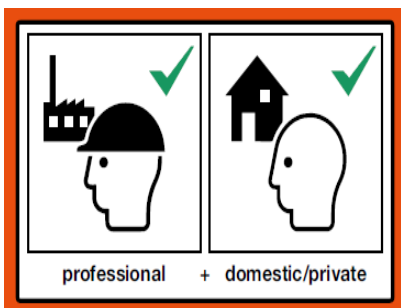
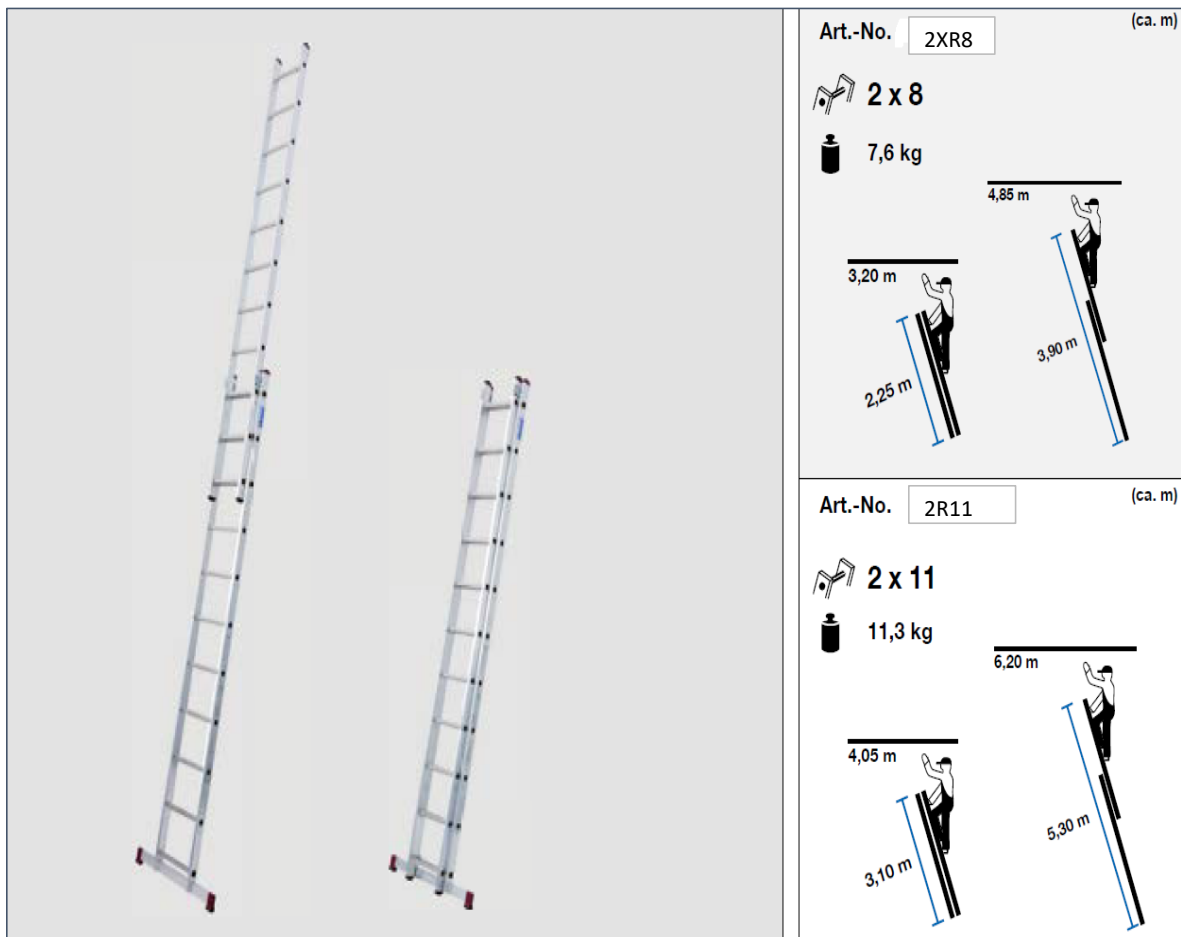



**EN-131**

**iStr!x**

**PROFESSIONELE REFORM - SCHUIFLADDERS ALU**  
**ECHELLES COULISSANTES- TRANSFORMABLES ALU**

3XR7	3 x 7 treden/échelons	4009199030375	€ 260,41
3XR9	3 x 9 treden/échelons	4009199030399	€ 327,90
3R11	3 x 11 treden/échelons	4009199030429	€ 425,95

**Art.-No.** 3XR7 (ca. m)

 **3 x 7**  
 **10,0 kg**



2,95 m  
1,95 m

3,20 m  
1,85 m

3,75 m  
2,95 m

5,10 m  
4,20 m

**Art.-No.** 3XR9 (ca. m)

 **3 x 9**  
 **13,5 kg**



3,50 m  
2,50 m

3,75 m  
2,40 m

4,55 m  
3,75 m

6,20 m  
5,30 m

**Art.-No.** 3R11 (ca. m)

 **3 x 11**  
 **18,0 kg**

4,30 m  
2,95 m

5,35 m  
4,55 m

7,25 m  
6,45 m



**EN-131**

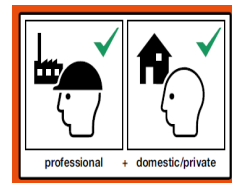

**iStr!x**

## LADDER - ECHELLE 2 x -X STEPS

BSS2	Aluminium ladder - échelle alu 2 x 2 treden	62,00 €
BSS3	Aluminium ladder - échelle alu 2 x 3 treden	79,00 €
BSS4	Aluminium ladder - échelle alu 2 x 4 treden	89,00 €
BSS5	Aluminium ladder - échelle alu 2 x 5 treden	125,00 €





## Vouwladder alu - profesionelle échelle pliante

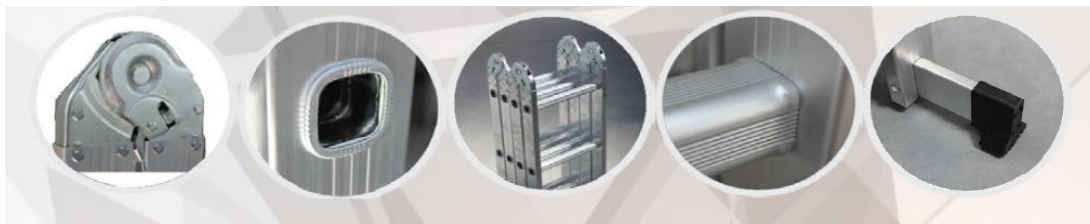
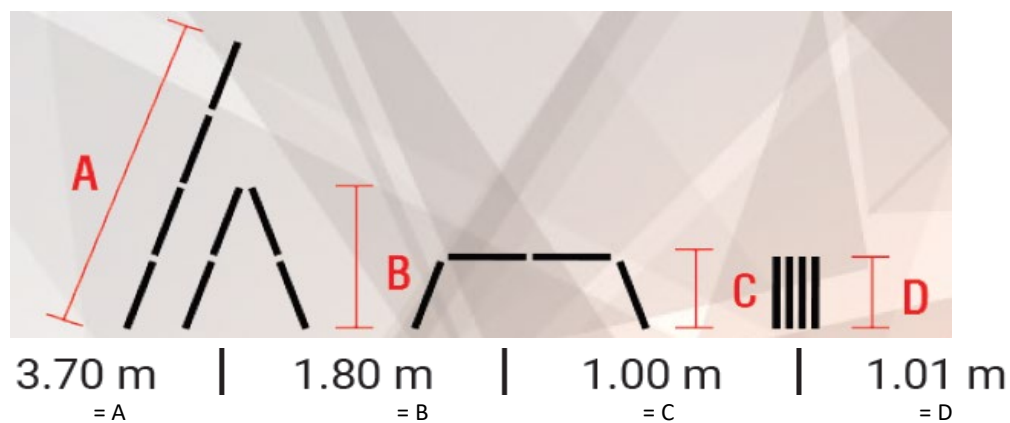

HML-103	12Kg	vouwladder 4x3 alu - échelle pliante + plaat	217,00
---------	------	--	--------

Automatische vergrendeling van de scharnieren in elke stand  
 Verrouillage automatique des charnières dans chaque position  
 Zware scharnieren  
 Charnières extra lourdes

**EN-131**

# COMBO-VOUWLADDER/ECHELLE



max : 150 kg  
 gewicht / poids = 12,50 kg  
 transport = 154 x 64 x 20cm  
 max lengte = 5,25 m

**EN-131**

HML-305	COMBO LADDER 4 X 5 TREDEN	350 €
---------	---------------------------	-------

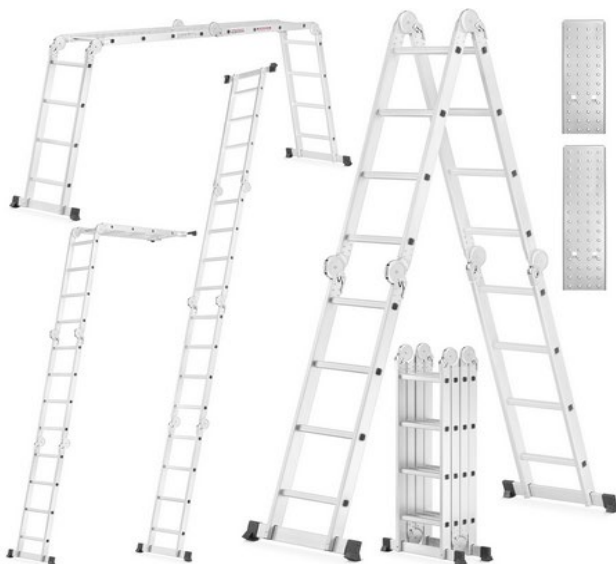

VL-P

VL-44P

**EN-131**

HVL-44P	VOUWLADDER 4 X 4 TREDEN +PLAAT	€ 323,00
---------	--------------------------------	----------

HVL-P	PLAAT VOOR VOUWLADDER 4x3	€ 69,10
-------	---------------------------	---------

## TELESCOPISCHE LADDERS - ECHELLES TELESCOPIQUES



**NEW**

EN-131

Max 150 kg

HTL-320	3,20m HOOGTE - HAUTEUR + BAG - WERKHOOGTE 4,80m <i>transport measures = 48 x 8,5 x 82cm      gewicht/poids = 8,3 kg</i>	€ 263,00
HTL-380	3,80m HOOGTE - HAUTEUR - WERKHOOGTE 5,10m <i>transport measures = 49 x 8,5 x 87,5cm      gewicht/poids = 10,3 kg</i>	€ 280,00
HTL-440	4,40m HOOGTE - HAUTEUR - WERKHOOGTE 5,70m <i>transport measures = 500 x 100 x 940mm      gewicht/poids = 12,00 kg</i>	€ 297,00



**NEW**

Max 150 kg





HTL-219	3,80 m HOOGTE - HAUTEUR - WERKHOOGTE 5,10m <i>transport measures = 48 x 16 x 88cm      gewicht/poids = 13,60 kg</i>	€ 280,00
HTL-220	4,40 m HOOGTE - HAUTEUR - WERKHOOGTE 5,70m <i>transport measures = 48 x 17 x 91cm      gewicht/poids = 15,20 kg</i>	€ 350,00
HTL-225	5,00 m HOOGTE - HAUTEUR - WERKHOOGTE 6,30m <i>transport measures = 52 x 21 x 94cm      gewicht/poids = 17,20 kg</i>	€ 390,00

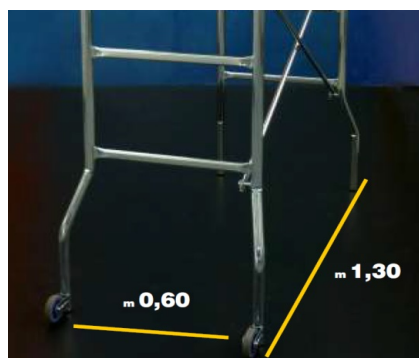
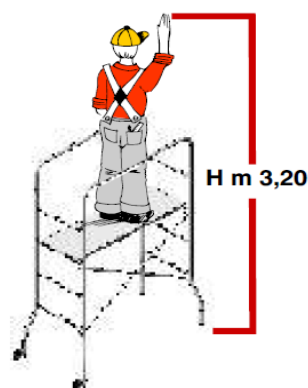

# FAST-TRIO



max gewicht/poids

				
1,88	1,18	30	600	20,00

**TRIO** Essential for small domestic maintenance, **easy to transport**, not bulky, **shrink-wrap film packed**, very quick to assemble, **it passes through doors** without the need to compact or dismantle it. **Package dimensions 163x55x10 cm**, transportable by car. Made of **galvanized steel**. Uprights in  $\varnothing$  30 mm tubular steel. **Work platform included**. Equipped with **wheels** for easy movement. Shrink-wrap film packaging







# FAST-TRIO ref IS20072

Montage handleiding – instructions de montage :

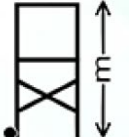
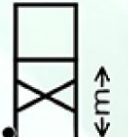

**NL** = aan elke zijde van de stelling moeten er 2 diagonalen geplaatst worden, beide aan de binnenzijde – snel en eenvoudig monteerbaar, platform meegeleverd en gemakkelijk in hoogte verstelbaar – gemakkelijk te verplaatsen dankzij de 2 wielen

**FR** = il faut monter deux diagonales à côté de l'échafaudage, deux à côté de l'intérieur – montage facile et rapide – facile à déplacer grâce aux 2 roues – plat-forme réglable en hauteur.

						bar - code bar - code
1,88	1,45	3,45	600	20,00	0,09	



**iStr!x**

Invoerder : Istrix bvba  
Oudenaardsesteenweg 397  
8581 Avelgem – Belgium  
[info@istrix.be](mailto:info@istrix.be)

## PLOOIBARE STELLING - ECHAFAUDAGE PLIANT

EN-131

FS290	opvouwbare stelling - échafaudage pliant	4009199916181	€ 450,00
-------	--	---------------	----------

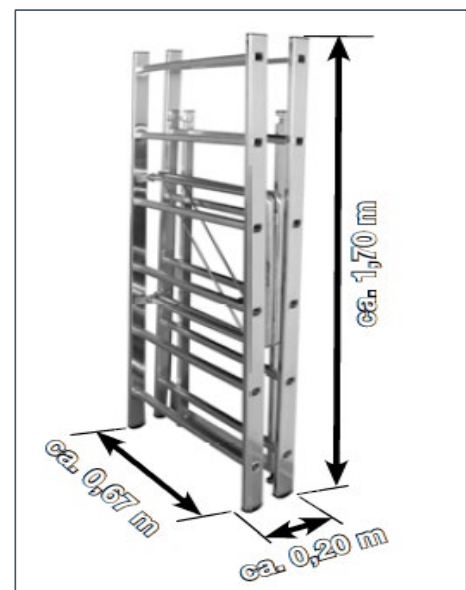
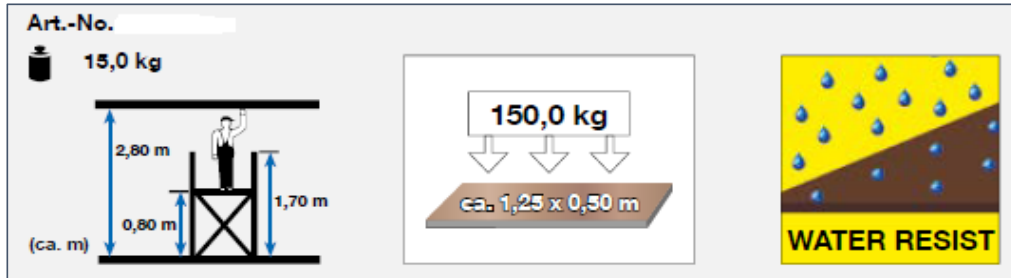

iStr!x

# MINIO - Aluminium stelling / échaufadage

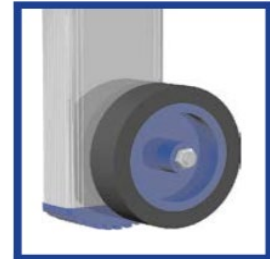
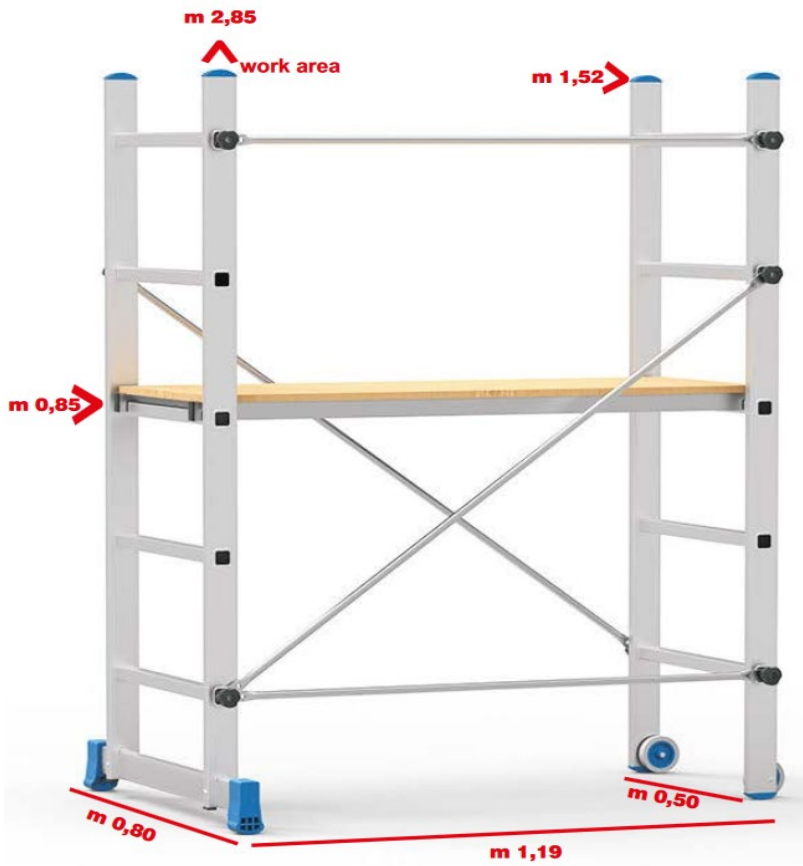

20782	Aluminium work-height 3 M	8021227005786	341.00
-------	---------------------------	---------------	--------

## Packaging



**Kg 120** Total load permitted

- Base dimension m 0,80X1,19

code	art.							€	bar - code bar - code
		E	E	mm	mm	Kg	vol. mc		
20782	Minio	1,52	0,85	60X25	500	16,00	0,09		

**STELLING WERKHOOGTE 3M - ECHAFAUDAGE HAUTEUR TRAVAIL 3M**

916174 | stelling met wielen - echafaudage + roues | 4009199916174 | 450,00

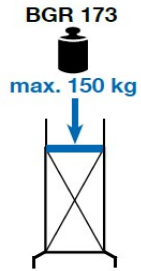
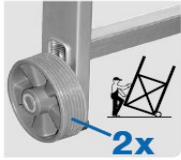

<b>A</b>	<b>B</b>	<b>C</b>	<b>A</b>		
3,00	1,95	1,00	2,00	18,0	

**EN-131**

- Gemakkelijk te verplaatsen dmv de stevige wielen
- Ook op trappen te gebruiken
- Montage geen problemen dmv gebruik van vleugelmoeren
- Facile à déplacer grâce aux grandes roues
- Peut également être utilisé sur des escaliers
- Montage rapide grâce aux écrous aux oreilles

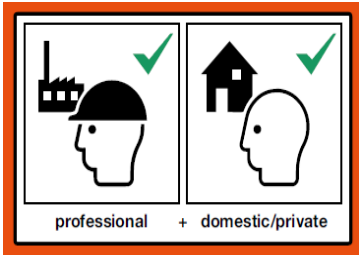

# STELLING - ECHAUFADAGE 2 X 8 TREDEN



HML-1108	STELLING 2 X 8 TREDEN + 2 WIELEN ECHAUFADAGE 2 X 8 STEPS + 2 ROUES	€ 350,00
----------	---	----------

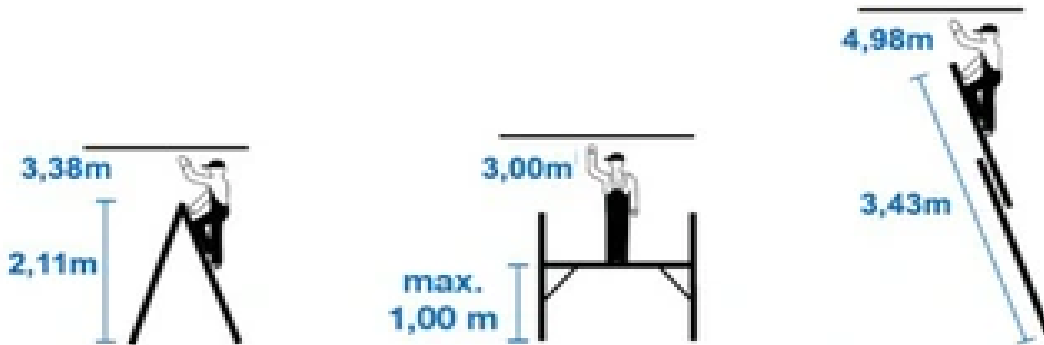



# Echafaudage à échelles articulées – stelling werkhoogte 4m

HOME + PROFESSIONAL USE

916341 stelling –échafaudage 4 M ( zonder wielen) 950,00 €

EN-131

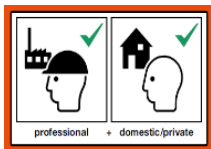
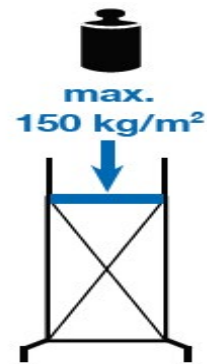
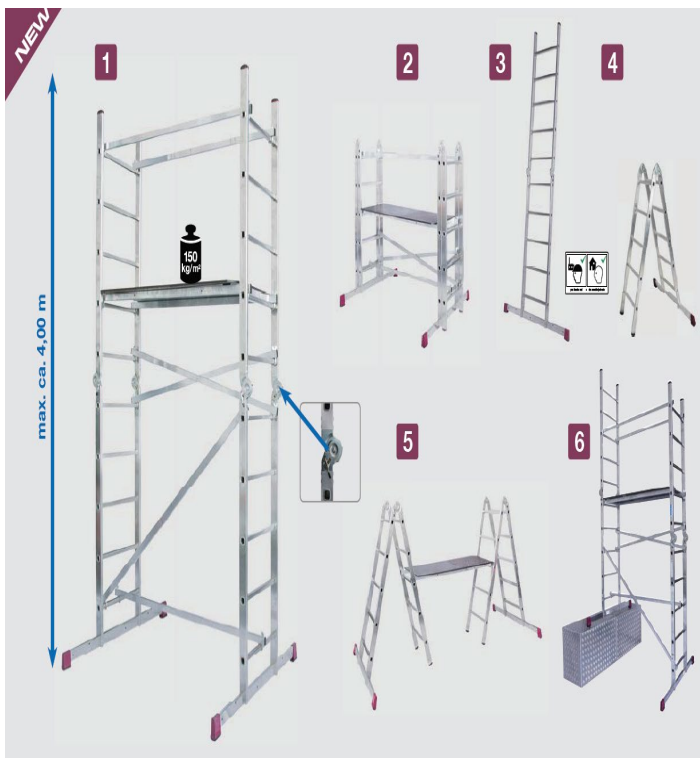

1	2	3	4	5	(ca. m)	
A B C	A B C	A B	A B	A B C	A	
4,00 3,00 2,00	2,90 1,55 0,90	3,90 3,00	2,75 1,50	2,90 1,50 0,90	2,15	30,0

The **new** mobile scaffold system:

**The benefits ...**





# ... at a glance

**45%** **Faster assembly!**  
 Assembly times are approx. 45% faster than with the old system



The innovative railing frame ensures easy and safe mounting as the diagonal struts are fully integrated.

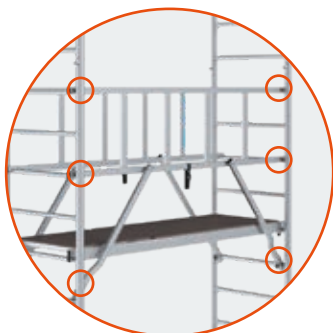

The 6-point fixing system ensures maximum stability at any height.



The innovative shape of the diagonal struts offers one of the widest useful platform sizes available on the market.

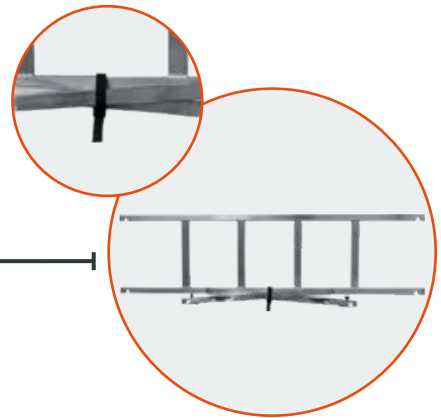

For compact transport or storage, the railing frame can be attached with the integrated belt strap.

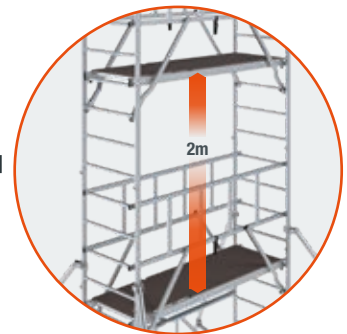

The number of platforms increases with the working height. Therefore, a maximum distance of 2 m is ensured.



Positive-action semi-automatic diagonal connections enable easy, fast and safe installation.

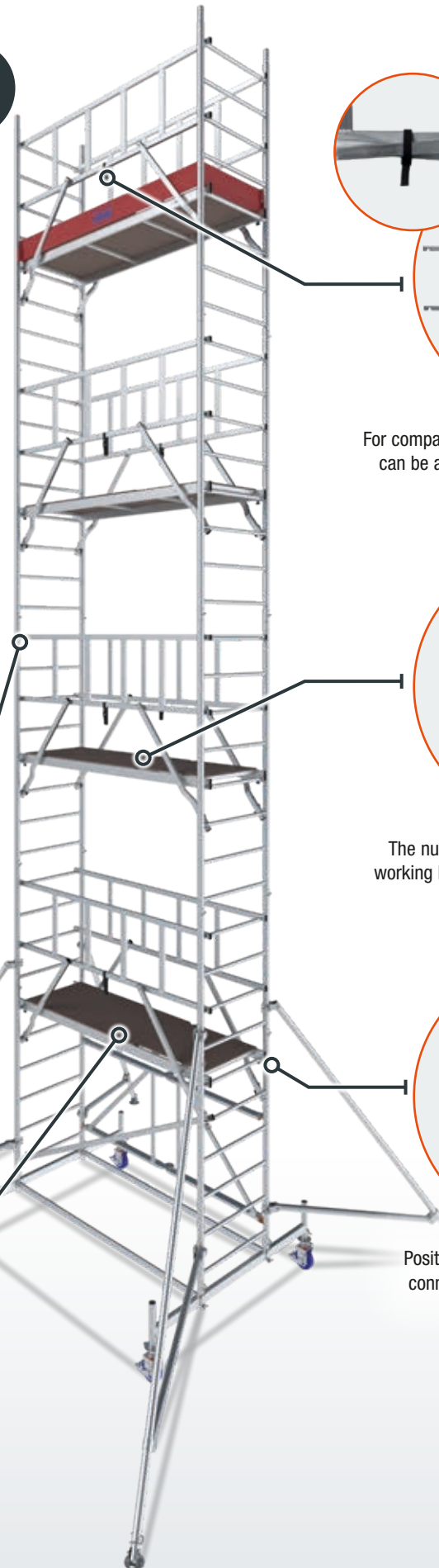



Working height: 2.90 m  
Platform height: 0.90 m  
Scaffold height: 2.30 m



Working height: 4.30 m  
Platform height: 2.30 m  
Scaffold height: 3.50 m



Working height: 5.30 m  
Platform height: 3.30 m  
Scaffold height: 4.50 m



Working height: 6.30 m  
Platform height: 4.30 m  
Scaffold height: 5.50 m

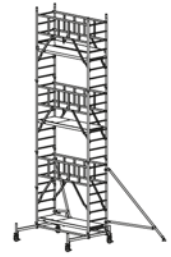

Working height: 7.30 m  
Platform height: 5.30 m  
Scaffold height: 6.50 m

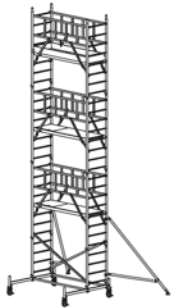

Working height: 8.30 m  
Platform height: 6.30 m  
Scaffold height: 7.50 m

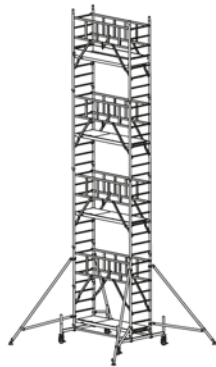

Working height: 9.30 m  
Platform height: 7.30 m  
Scaffold height: 8.50 m

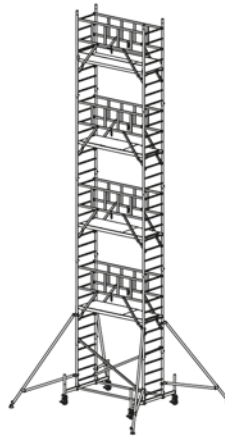

Working height: 10.30 m  
Platform height: 8.30 m  
Scaffold height: 9.50 m

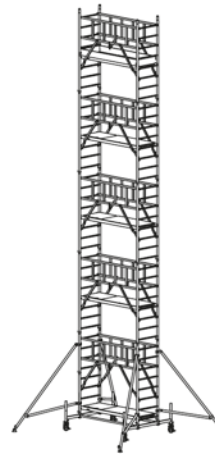

Working height: 11.30 m  
Platform height: 9.30 m  
Scaffold height: 10.50 m

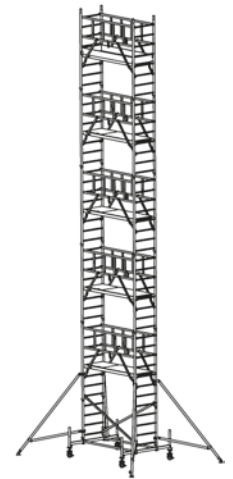

Working height: 12.30 m  
Platform height: 10.30 m  
Scaffold height: 11.50 m

**Field length of scaffold: 2.00 m – Field width of scaffold: 0.70 m**

	A up to approx.	m	2.90	4.30	5.30	6.30	7.30	8.30	9.30	10.30	11.30	12.30
	B approx.	m	0.90	2.30	3.30	4.30	5.30	6.30	7.30	8.30	9.30	10.30
	C approx.	m	2.30	3.50	4.50	5.50	6.50	7.50	8.50	9.50	10.50	11.50
Floor area	m	1.62 x 2.00	1.62 x 2.00	1.62 x 2.00	1.62 x 2.00	2.85 x 3.65	2.85 x 3.65	3.55 x 3.65	3.55 x 3.65	3.55 x 3.65	3.55 x 3.65	3.55 x 3.65
Weight	kg	44.0	87.0	109.0	118.0	155.0	164.0	202.0	211.0	233.0	241.0	
Art.-No.		940100	940117	940124	940131	940148	940155	940162	940179	940186	940193	
BRUT PRICE		1969.80	3208.75	4099.00	4533.00	5944.95	6374.20	7519.00	7945.00	8953.00	9385.00	

Parts list	Art.-No.	Quantity	Quantity	Quantity	Quantity	Quantity	Quantity	Quantity	Quantity	Quantity	Quantity
Vertical frame 2.00 m	915016	2	2	3	4	5	6	7	8	9	10
Vertical frame 1.00 m	915023	0	2	2	2	2	2	2	2	2	2
Platform with hatch 2.00 x 0.60 m	911001	1	1	2	2	3	3	4	4	5	5
Diagonal brace	912879	1	2	0	2	0	2	0	2	0	2
Rail brace	912855	1	0	0	0	0	0	0	0	0	0
Base brace 2.00 m	912848	0	2	2	2	2	2	2	2	2	2
Stabiliser	914071	0	2	2	2	2	2	2	2	2	2
Outtrigger	914095	0	0	0	0	2	2	4	4	4	4
Longitudinal board 0.70 m	913555	0	2	2	2	2	2	2	2	2	2
Transversal board 2.00 m	913517	0	2	2	2	2	2	2	2	2	2
Set of castors Ø 150 mm, height-adjustable	914323	1	1	1	1	1	1	1	1	1	1
Foot plate	914026	4	4	4	4	4	4	4	4	4	4
Gravity pin	704405	4	8	10	12	14	16	18	20	22	24
GuardMatic-System	910073	0	2	4	4	6	6	8	8	10	10

**Accessories**

Set of stabilisers 1.2 m	Set of stabilisers 1.5 m	Ballast weight	Set of castors Ø 150 mm, height-adjustable	Safety set for rail brace/diagonal brace M5 x 65 mm	Safety set for platform M5 x 95 mm
Art.-No. 910059	Art.-No. 910066	Art.-No. 704306	Art.-No. 914118	Art.-No. 718914	Art.-No. 718853

**BOUWEMMER - SEAU DE MAÇON**

IS000928	12 liter	3,63	
310Dx240H			5 4 3 0 0 0 1 2 5 1 4 2 5

IS003967	20 liter	6,79	
365Dx280H			5 4 3 0 0 0 1 2 5 1 1 6 6

**BOUWEMMER + SCHENKTUIT  
SEAU DE MAÇON + BEC VERSEUR**

IS008303	12 liter	3,75	
310Dx240H			5 905197 155678

IS011112	20 liter	7,03	
365Dx280H			5 905197 155968

**MORTELBAK RECHTHOEKIG  
BAC A MORTIER RECTANGULAIRE**

IS011527	40 liter	12,79	
720Lx410Bx220H			5430001251111

IS011528	60 liter	15,35	
720Lx410Bx285H			5 430001 251128

IS011529	80 liter	18,51	
780Lx480Bx300H			5 430001 251135

**MORTELKUIP  
CUVELLE A MORTIER**

IS011111	40 liter	13,75	
510Dx280H			5 4 3 0 0 0 1 2 5 1 0 8 1

IS001078	65 liter	16,04	
590Dx330H			5 430001 251098

IS001077	90 liter	20,8	
660Dx360H			5 430001 251104

IS12028	110 liter	62,00	
71Dx39H			8 006417 002622

IS12030	210 liter	97,75	
80Dx55H			8 006417 004756

IS12031	230 liter	130,50	
85Dx55H			8 006417 002638

Bouw-Construction / Jardin - Tuin FLEXITUB



REF.:1166002



Dim ( 34,5 x 24 x 24 ) cm

1166002	15 L flexibele tub	12	5,16
---------	--------------------	----	------



REF.:1187202



Dim ( 42 x 38 x 32,5 ) cm

1187202	25 L flexibele tub	12	8,47
---------	--------------------	----	------



REF.:11433



Dim ( 48,5 x 45 x 38 ) cm

11433	42 L flexibele tub	12	12,3
-------	--------------------	----	------



REF.:1187302



Dim ( 59,5 x 52,5 x 38 ) cm

1187302	56 L flexibele tub	12	14,85
---------	--------------------	----	-------

# METERSSCHOOR-ETAI DE MACON

gewicht = poids 8,10kg

max gewicht/poids at 290cm extension= kg 910

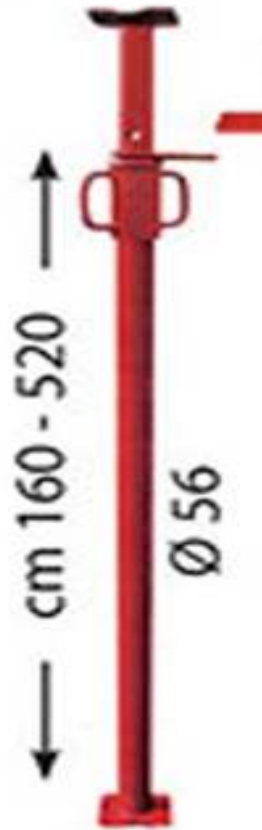

1,60 m-2,90m

160290



Metersschoor - étau de maçon





## Soldeerbranders - torche à souder PIEZO 190Gr



E450101



I006433

E45010	Ergonomic handle made of high temperature resistant polypropylene	49,69
I006433	Soldering torch 190gr gas capsule	40,93

## Gas capsule - gaz camping capsule 190gr



I002783	Gas capsule 190gr buto	3,39
---------	------------------------	------

## Handle Mixer 1600W 0-750min-1 RD-HM11



R078511	3800972019720	Raider hand mixer 1600W	€ 197,00
---------	---------------	-------------------------	----------



R020152	3800972000810	125mm 1200W variable speed BMC + discs RD-G-54	€ 109,00
---------	---------------	--	----------

## DIAMANT SLIJPSCHIJF - DISQUE DIAMANT



150MM DIAM

Designed for dry cutting in concrete, bricks, faience

Made in accordance with the requirements of EN 13236 standard

230MM DIAM

		#	€
E162124	Diamant slijpschijf 150mm x 22,2 mm	1	10,8
	Disque diamant 3800972022669		
E162111	Diamant slijpschijf 230mm x 22,2 mm	1	23,75
	Disque diamant 3800123126499		



		#	€
E010142	Boormachine 1050W 230V 13mm	1	132,0
	Perceuse 3800972018891		



## KABELSCHAAR - PINCE COUPE CABLE

TOP MASTER PROFESSIONAL



**NEW**

		#	€
E370805	Kabelschaar 24" lengte 60cm	1	46.50
	Pince coupe cable	3800123111006	
	<i>cutting capacity 30mm<sup>2</sup></i>		

		#	€
E370806	Kabelschaar 32" lengte 80cm	1	82.60
	Pince coupe cable	3800123126819	
	<i>cutting capacity 60 mm<sup>2</sup></i>		

## ALL PURPOSE KNIFE 18x165mm METAL HEAD



**NEW**

		#	€
E370104	Afbreekmes alle doeleinden 18x165mm	1	1,78
	Couteau de coupeur 18mm	3800123107184	

## ALL PURPOSE KNIFE 18x165mm PLASTIC BS



**NEW**

		#	€
E370143	Afbreek mes alle doeleinden 18x155mm	1	0,89
	Couteau de coupeur 18mm	3800123139253	

## SCHRAGEN - TRETEAU



75 X 75 CM - 60 à 80 Kg -

Vouwpoten voor compacte opslag en handige draagbaarheid

F498950	Dennehout - bois de pin	€ 15,88
---------	-------------------------	---------

# Tréteau métal réglable



In gelakte buis  
8 instelbare hoogtes min / max 115,5 / 192,5 cm  
afmeting 90x63 cm  
En tubulaire peint  
8 hauteurs réglables min / max 115,5 / 192,5 cm.  
Taille 90x63 cm

F334010	metalen verstelbare schraag	1	182,50 €
---------	-----------------------------	---	----------

## VERKEERSKEGELS - CONES DE SIGNALISATION



F400950	33 CM HOOGTE - HAUTEUR	20pcs	€ 13,20
F400955	53 CM HOOGTE - HAUTEUR	10pcs	€ 16,50

**DUIMSTOK = PLOOIMETER = METRE PLIANT**

**DE GOEDE KEUZE  
MAAKT DE VAKMAN**

- > FLEXIBILITEIT
- > NAUWKEURIGHEID
- > SOEPELHEID

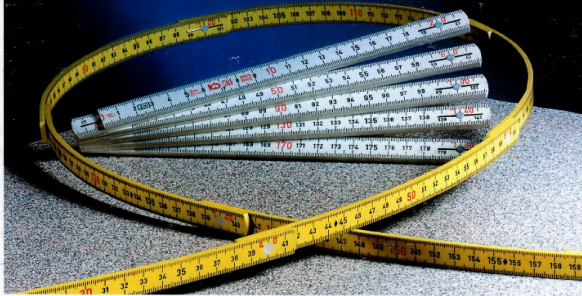

Zeer fijne en preciese bedrukking.  
Verschillende kleuren beschikbaar - Waterbestendig



Al onze meters zijn geijkt en voldoen  
aan de Europese en Belgische voorschriften.



**LE BON CHOIX  
FAIT L'EXPERT**

- > FLEXIBILITÉ
- > SOUPLESSE
- > PRÉCISION

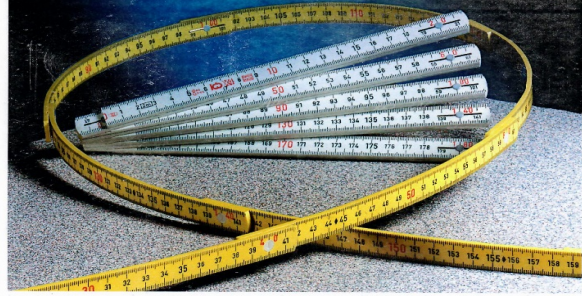



Impressions très nettes et précises.  
Différents coloris - Résistant à l'eau



Tous nos mètres sont poinçonnés conformément  
aux prescriptions européennes et nationales.



4102004		Long life plooiometer wit - mètre pliant blanc Longlife 2 m	13.56
4102001		Longlife duimstok geel plus/ mètre pliant jaune plus 2m	16,00



Glasvezelversterkt polyamide is scheur-, kras- en zeer buigvast, chemicaliënbestendig en zwelt niet op bij contact met water

Le polyamide renforcé de fibres de verre est résistant aux rayures, aux griffes et en particulier à la flexion, résistant aux produits chimiques et ne gonfle pas au contact de l'eau





1982 was the year in which Tre Emme S.p.A. was born that today represents a holding of four companies located in Italy.

The continuous investments in new products and new production technology have allowed the company to grow continuously, always acquiring more space in the traditional market and also the DIY market to become the leader in its sector.

The principal categories of production are:

**Draught Excluders** (extruded foam in strips and sheets, adhesive and non adhesive)

**Extruded plastic materials** (for the realisation of products, examples of which are barrier tapes, cover sheets in polythene, seals in PVC - adhesive and non adhesive)

**Adhesive tapes** (including packing tapes, masking tape, insulation, cloth, antislip and many more)

The Company occupies more than 30.000 m<sup>2</sup> of covered space which includes the production departments and merchandise warehousing.

It relies on more than 60 employees and a whole network of 42 national sales agents that contribute every day to make our main brand GEKO more important.



# Geko OFFICE - TRANSPARENT

Transparent adhesive tapes. Useful at home, office and school

TRANPARANT KLEEFBAND - HANDIG VOOR THUIS, SCHOOL, KANTOOR

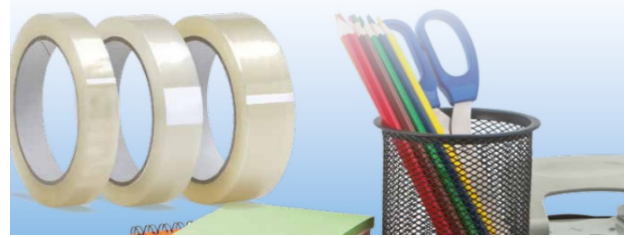

14400/2	8014846530319	TRANSPARENT TAPE MM15 X 10M WITH DISPENSER IN DISPLAY OF 100PCS	1	76.38
---------	---------------	--	---	-------



14200/6	8014846530128	TRANSPARENT TAPE MM19 X 66M IN CLOSED BOX	12	3.46
14200/8	8014846530135	TRANSPARENT TAPE MM25 X 66M IN CLOSED BOX	12	4.26



## STANDARD :

18000/54	8014846531071	PACK STANDARD TAPE MM50 X 66M BROWN FRONT LABEL	36	3.28
18000/56	8014846531088	PACK STANDARD TAPE MM50 X 66M TRANSPARENT FRONT	36	3.28



**STANDARD :**

18000/40	8014846534744	PACK STANDARD TAPE MM 50 X 66M HAVANA SIDE LABEL	36	2.28
18000/42	8014846531347	PACK STANDARD TAPE MM 50 X 66M TRANSP SIDE LABEL	36	2.28

**TOP QUALITY :**

18000G102	8014846534522	PACK PVC TAPE MM 50 X 66 M BROWN WITH FRONT LABEL	36	6.78
18000G101	8014846534492	PACK PVC TAPE MM 50 X 66 M TRANSPARENT SIDE LABEL	36	5.93
IS18000/101	5430001251302	PACK PVC TAPE MM 48 X 66 M BROWN WITH FRONT LABEL	24	3,10
IS18000/100	5430001251319	PACK PVC TAPE MM 48 X 66 M TRANSPARANT- FRONT LABEL	24	3,10

**LOW NOISE :**

18000/82	8014846531217	PACK LOW NOISE TAPE MM 50 X 66 M HAVANA FRONT LABEL	36	4.23
18000/86	8014846531231	PACK LOW NOISE TAPE MM 50 X 66 M TRANSP FRONT LABEL	36	4.23
18000/84	8014846531224	PACK LOW NOISE TAPE MM 50 X 66 M WHITE FRONT LABEL	36	4.23

**ECO PAPER :**

18000/106	8014846534560	PACK ECO PAPER TAPE MM 50 X 50 M WITH FRONT LABEL	36	6.74
-----------	---------------	---	----	------

**TEAR BY HAND :**

18000/66	8014846531507	PACK STANDARD TAPE MM 50 X 66 M BROWN SIDE LABEL	36	3.33
18000/68	8014846531514	PACK STANDARD TAPE MM 50 X 66 M TRANSP SIDE LABEL	36	3.33





**STRONG :**

18000/26	8014846530937	PACK PLP TAPE MM 50 X 66 M HAVANA FRONT LABEL	36	3.78
18000/28	8014846530944	PACK PLP TAPE MM 50 X 66 M TRANSPARENT FRONT LABEL	36	3.78
18000/30	8014846530951	PACK PLP TAPE MM 50 X 66 M WHITE FRONT LABEL	36	3.78
18000/22	8014846530913	PACK PLP TAPE MM 50 X 66 Y TRANSPARENT SIDE LABEL	36	3.29



41000/17



= 18000/702



41000/15-14

**DISPENSER :**

41000/17	8014846706240	DISPENSER FOR PACKAGING TAPE 50MM STANDARD	1	15.43
18000/702	8014846531453	PACK NOISE TAPE MM 50 X 66 M HAVANA 2 PCS	14	19.88
		+ DISPENSER WITH SIDE LABEL		
41000/15	8014846706226	TABLETOP DISPENSER FOR OFFICE TAPE 33M	1	6.86
41000/14	8014846706219	TABLETOP DISPENSER FOR OFFICE TAPE 66M	1	10.40



18000/900	8014846531583	SELF ADHESIVE PACKING TAPE - <b>EXTRA STRONG PLP</b>	36	3.93
-----------	---------------	--	----	------

MM 50 X 66 M WITH SIDE LABEL  
(blue tint but transparent applied to a carton)

## Geko - Strong + tear by hand Packing



*Adhesive strapping tapes. Useful for pallets, tubes, wooden planks, sheets, etc.  
Highest tear resistance*

26000	8014846532863	STRAPPING TAPE MM 19 X 66 Y WITH SIDE LABEL	96	3.19
26000/2	8014846532870	STRAPPING TAPE MM 25 X 66 Y WITH SIDE LABEL	72	4.13



*Fiberglass reinforced unidirectional and bidirectional tapes.  
Highly resistant to tear. Ideal for closing cartons with heavy contents*

27000	8014846533365	REINFORCED MONO DIRECTIONAL TAPE MM19 X 50 Y WITH SIDE LABEL	96	4.86
27000/2	8014846533372	REINFORCED MONO DIRECTIONAL TAPE MM25 X 50 Y WITH SIDE LABEL	72	6.46
27000/4	8014846533389	REINFORCED MONO DIRECTIONAL TAPE MM50 X 50 Y WITH SIDE LABEL	36	12.74



## Geko - shop + plastic adhesive tape



*Adhesive tapes ideal for closing polybags*

41000/24	8014846545221	SEALING TAPE FOR BAGS MM 9 X 66 M BLUE BULK	30	2.29
41000/20	8014846545207	SEALING TAPE FOR BAGS MM 9 X 66 M RED BULK	30	2.29
41000/22	8014846545214	SEALING TAPE FOR BAGS MM 9 X 66 M YELLOW BULK	30	2.29



41000/16	8014846706233	DISPENSER FOR POLYBAG SEALING TAPE 9/12	1	37.36
----------	---------------	---	---	-------

# Geko SAFETY - SIGNAL



Adhesive barrier tape in pvc of high thickness. Useful in warehouses or in industry to delimit a workzone (yellow/black) or indicate dangerous areas and the position of fire extinguishers (white/red)

18030/6	8014846533334	ADHESIVE PVC TAPE MM50 X 30M BLACK/YELLOW WITH FRONT LABEL	36	11.80
IS18030/6	5430001251210	ADHESIVE PVC TAPE MM50 X 30M YELLOW/BLACK WITH SIDE LABEL	24	8,50
18030/4	8014846533327	ADHESIVE PVC TAPE MM50 X 30M RED/WHITE WITH FRONT LABEL	36	11.80
IS18030/4	5430001251258	ADHESIVE PVC TAPE MM50 X 30M RED/WHITE WITH SIDE LABEL	24	8,50



Adhesive anti-skid tapes, particularly indicated for those surfaces where you can walk barefoot, . as shower trays, bathtubs, swimming pools, etc colour: transparent.

220/56	8014846519840	ADHESIVE ANTI-SKID TAPE MM 25 X 5 M TRANSPARENT IN CLOSED BOX	12	12.05
--------	---------------	---	----	-------



Adhesive anti-slip tapes, particularly indicated for slippery, sloping and dangerous surfaces. Thanks to their waterproofing and resistance, they can be used either in interiors or in outer places

220/52	8014846519802	ADHESIVE ANTI-SLIP TAPE MM 25 X 5 M BLACK IN CLOSED BOX	12	8.60
IS220/5	5430001251265	ADHESIVE ANTI-SLIP TAPE MM 50 X 10 M BLACK IN CLOSED BOX	24	10,5
220/58	8014846519857	ADHESIVE ANTI-SLIP TAPE MM 25 X 5 M FLUORESCENT IN CLOSED BOX	12	12.41
220/54	8014846519826	ADHESIVE ANTI-SLIP TAPE MM 25 X 5 M TRANSPARENT IN CLOSED BOX	12	9.18
220/53	8014846519819	ADHESIVE ANTI-SLIP TAPE MM 25 X 5 M WHITE IN CLOSED BOX	12	8.60
220/55	8014846519833	ADHESIVE ANTI-SLIP TAPE MM 25 X 5 M YELLOW/BLACK IN CLOSED BOX	12	8.72

# Geko - bande de chantier / werf veiligheidslinten

niet - zelfklevend / pas auto-collant



Reflective white/red with perfect visibility at night and in bad weather conditions  
yellow/black

200G10	8014846701009	mm 70 x 100 m, red/white, in closed box Geko brand	24	3.71
200/11	8014846701016	mm 70 x 100 m, red/white, in bulk	24	3.40
200/2	8014846092060	mm 70 x 200 m, red/white, in closed box Geko brand	24	4.77
200/14	8014846705007	mm 70 x 500 m, red/white, in closed box Geko brand	12	13.03
200/6	8014846092008	mm 70 x 200 m, yellow/black, in closed box Geko brand	24	5.10

## GEKO SIGNAL REFLECTOR



205G11	8014846706028	REFLECTOR SIGNAL white/red mm 70 X 100 M BULK	24	21.10
--------	---------------	---	----	-------



# Geko - SECURITY



Adhesive antislip tape for carpets, rugs □

220/200	8014846521003	ADHESIVE ANTISLIP TAPE FOR CARPETS MM25 X 5M IN CLOSED BOX	12	3.99
---------	---------------	--	----	------



Twin fluorescent and reflective adhesive tapes. High visibility during the day also at night. Extremely useful for bikers, motorbikers and any other activities requiring high visibility

31500/1	8014846590009	NIGHT & DAY REFLECTIVE AND FLUORESCENT TAPE 19MM X 2,5M IN OPEN BOX	12	11.56
---------	---------------	---	----	-------



Phosfo adhesive tapes. High visibility during the day and night.

220/202	8014846521027	ADHESIVE ANTI-SKID TAPE MM 25 X 3 M LUMINESCENT (GLOW IN THE DARK) CLOSED BOX	12	19.36
---------	---------------	---	----	-------

# Geko - TEX

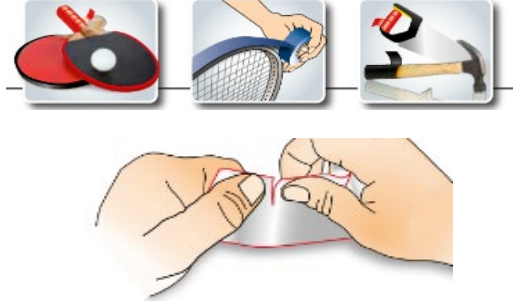

Plasticized cloth adhesive tape. Waterproof, useful at home, office, school and leisure time

14300/6	8014846530173	TEX TAPE MM 19 X 2,7 M BLACK IN CLOSED BOX	24	3.95
14300/8	8014846530180	TEX TAPE MM 19 X 2,7 M BLUE IN CLOSED BOX	24	3.95
14300/30	8014846530296	TEX TAPE MM 19 X 2,7 M BROWN IN CLOSED BOX	24	3.95
14300/2	8014846530159	TEX TAPE MM 19 X 2,7 M GREEN IN CLOSED BOX	24	3.95
14300/12	8014846530203	TEX TAPE MM 19 X 2,7 M GREY IN CLOSED BOX	24	3.95
14300	8014846530142	TEX TAPE MM 19 X 2,7 M RED IN CLOSED BOX	24	3.95
14300/4	8014846530166	TEX TAPE MM 19 X 2,7 M WHITE IN CLOSED BOX	24	3.95
14300/10	8014846530197	TEX TAPE MM 19 X 2,7 M YELLOW IN CLOSED BOX	24	3.95
14300/20	8014846530241	TEX TAPE MM 38 X 2,7 M BLACK IN CLOSED BOX	18	5.50
14300/22	8014846530258	TEX TAPE MM 38 X 2,7 M BLUE IN CLOSED BOX	18	5.50
14300/28	8014846530289	TEX TAPE MM 38 X 2,7 M BROWN IN CLOSED BOX	18	5.50
14300/16	8014846530227	TEX TAPE MM 38 X 2,7 M GREEN IN CLOSED BOX	18	5.50
14300/26	8014846530272	TEX TAPE MM 38 X 2,7 M GREY IN CLOSED BOX	18	5.50
14300/14	8014846530210	TEX TAPE MM 38 X 2,7 M RED IN CLOSED BOX	18	5.50
14300/18	8014846530234	TEX TAPE MM 38 X 2,7 M WHITE IN CLOSED BOX	18	5.50
14300/24	8014846530265	TEX TAPE MM 38 X 2,7 M YELLOW IN CLOSED BOX	18	5.50



18000/705	8014846531569	PACK STANDARD TAPE MM50 X 66M 'FRAGILE' PRINTED TAPE WITH SIDE LABEL	36	6.19
-----------	---------------	---	----	------



# Geko - ADHESIVE CLOTH TAPE

Cloth american tape. Multipurpose and waterproof. Tears by hand in both direction. High performance

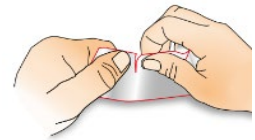

19100/2	8014846533259	CLOTH TAPE <b>BLACK</b> MM 50 X 25 M WITH SIDE LABEL	18	5.50
19100/3	8014846533754	CLOTH TAPE BLACK MM 50 X 50 M WITH SIDE LABEL	18	9.73
IS19000/6	5430001251241	CLOTH TAPE BLACK MM 50 X 50 M WITH SIDE LABEL	24	10.50
19000/46	8014846532993	CLOTH TAPE BLACK MM50 X 25M WITH FRONT LABEL	18	7.57
19000/4	8014846531279	CLOTH TAPE BLACK MM50 X 5M IN CLOSED BOX	18	5.31
19000/68	8014846533105	CLOTH TAPE <b>BLUE</b> MM 50 X 25 Y WITH SIDE LABEL	18	8.34
19000/8	8014846531293	CLOTH TAPE BLUE MM50 X 5M IN CLOSED BOX	18	5.31
19000/76	8014846533143	CLOTH TAPE <b>DESERT FANTASY</b> MM 50 X 25 Y SIDE LA	18	9.30
19000/72	8014846533129	CLOTH TAPE <b>GREEN</b> MM 50 X 25 Y WITH SIDE LABEL	18	8.34
19000/12	8014846532009	CLOTH TAPE GREEN MM 50 X 5 M IN CLOSED BOX	18	5.31
19000/74	8014846533136	CLOTH TAPE <b>JUNGLE FANTASY</b> MM 50 X 25 Y SIDE LA	18	9.30
19000/66	8014846533099	CLOTH TAPE <b>RED</b> MM 50 X 25 Y WITH SIDE LABEL	18	8.34
19000/44	8014846532986	CLOTH TAPE GREY MM50 X 25M WITH FRONT LABEL	18	7.57
19000/100	8014846533266	CLOTH TAPE <b>GREY</b> MM 50 X 50 M WITH FRONT LABEL	18	13.62
19100/1	8014846533242	CLOTH TAPE GREY MM 50 X 25 M WHIT SIDE LABEL	18	5.50
19100/4	8014846535901	CLOTH TAPE GREY MM 50 X 50 M WITH SIDE LABEL	18	9.73
IS19000/1	5430001251234	CLOTH TAPE <b>GREY</b> MM 50 X 50 Y WITH SIDE LABEL	24	10.5
19000/71	8014846533303	CLOTH TAPE <b>TRANSPARENT</b> MM 50 X 25 Y WITH SIDE LABEL	18	8.34
19000/42	8014846532979	CLOTH TAPE <b>WHITE</b> MM 50 X 25 M WITH FRONT LABEL	18	7.57
19000/60	8014846533068	CLOTH TAPE WHITE MM 50 X 25 Y WITH SIDE LABEL	18	6.99
19000/70	8014846533112	CLOTH TAPE <b>YELLOW</b> MM 50 X 25 Y WITH SIDE LABEL	18	8.34

# Geko - MASKING

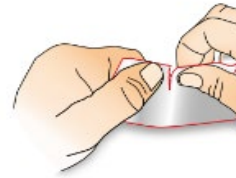

*Adhesive basic masking tape .*

21000G407	8014846536137	MASKING TAPE BASIC MM 38 X 50 M WHITE WITH SIDE LABEL	48	3.80
21000G401	8014846536106	MASKING TAPE BASIC MM19 X 50M WHITE WITH SIDE LABEL	96	2.03
21000G403	8014846536113	MASKING TAPE BASIC MM25 X 50M WHITE WITH SIDE LABEL	72	2.58
21000G405	8014846536120	MASKING TAPE BASIC MM30 X 50M WHITE WITH SIDE LABEL	60	3.08
21000G409	8014846536144	MASKING TAPE BASIC MM50 X 50M WHITE WITH SIDE LABEL	36	4.95

*Adhesive masking tape for general use. Solvent adhesive for diy use.  
Ideal in case of medium-low temperature*

21000/84	8014846532597	MASKING TAPE INTERNAL MM19 X 50M WITH FRONT LABEL	96	2,29
21000/86	8014846532603	MASKING TAPE INTERNAL MM 25 X 50M WITH FRONT LABEL	60	2.89
21000/88	8014846532610	MASKING TAPE INTERNAL MM 30 X 50M WITH FRONT LABEL	36	3.41
21000/90	8014846532627	MASKING TAPE INTERNAL MM 38 X 50M WITH FRONT LABEL	48	4.21
21000/92	8014846532634	MASKING TAPE INTERNAL MM 50 X 50M WITH FRONT LABEL	36	5.64

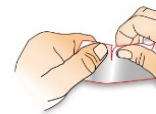

*Adhesive masking tape for professional use. It resist to 60 °c (to 80 °c for one hour).  
Solvent adhesive. Excellent performance.*

21000G710	8014846535253	MASKING TAPE PROFESSIONAL 60° C MM19 X 50M WITH FRONT LABEL	96	2.61
21000G712	8014846535260	MASKING TAPE PROFESSIONAL 60° C MM25 X 50M WITH FRONT LABEL	72	3.30
21000G714	8014846535277	MASKING TAPE PROFESSIONAL 60° C MM30 X 50M WITH FRONT LABEL	60	3.90

# Geko Msk low tack

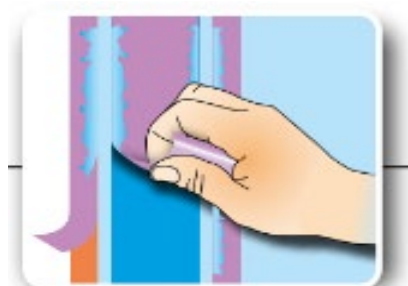

*Low adhesion adhesive masking tape.*

*Extremely useful on delicate surfaces and it does not leave a residue when removed*

21000/180	8014846534201	MASKING TAPE LOW TACK MM 19 X 50 M VIOLET LOW WITH FRONT LABEL	96	4.43
21000/182	8014846534218	MASKING TAPE LOW TACK MM 25 X 50 M VIOLET LOW WITH FRONT LABEL	72	5.65
21000/172	8014846534164	MASKING TAPE INTERNAL MM 25 X 50 Y VIOLET LOW WITH SIDE LABEL	72	4.89
21000/184	8014846534225	MASKING TAPE LOW TACK MM 30 X 50 M VIOLET LOW WITH FRONT LABEL	60	6.69
21000/186	8014846534232	MASKING TAPE LOW TACK MM 38 X 50 M VIOLET LOW WITH FRONT LABEL	48	8.35
21000/188	8014846534249	MASKING TAPE LOW TACK MM 50 X 50 M VIOLET LOW WITH FRONT LABEL	36	10.84



*Adhesive masking tape with paper made using japanese rice fibres  
resistant up to 95° - suitable for external use  
resistant to UV-rays for 60 days - precise lines*

21000/500	8014846534904	MSK WASHI - MM 19 X 50 M WITH FRONT LABEL	48	7.30
21000/504	8014846534928	MSK WASHI - MM 30 X 50 M WITH FRONT LABEL	30	11.49
21000/508	8014846534942	MSK WASHI - MM 50 X 50 M WITH FRONT LABEL	18	18.69

# Geko - Masking



Adhesive high crepe masking tape useful for masking curves and circles

21000/206	8014846534331	MASKING TAPE INTERNAL MM 25 X 50 M WITH FRONT LABEL	72	6.02
-----------	---------------	---	----	------

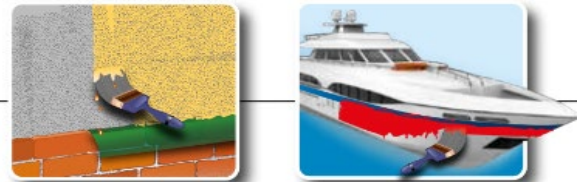

Adhesive masking tape resistant to uv rays fo 15 days.  
Ideal for external use and on boats. It does not leave a residue when removed

21000G132	8014846533969	BLUE MASKING TAPE PROFESSIONAL 15 DAYS UVR MM 19 X 50 M WITH FRONT LABEL	96	4.93
21000G134	8014846533976	BLUE MASKING TAPE PROFESSIONAL 15 DAYS UVR MM 25 X 50 M WITH FRONT LABEL	72	6.33
21000G136	8014846533983	BLUE MASKING TAPE PROFESSIONAL 15 DAYS UVR MM 30 X 50 M WITH FRONT LABEL	60	7.54
21000G138	8014846533990	BLUE MASKING TAPE PROFESSIONAL 15 DAYS UVR MM 38 X 50 M WITH FRONT LABEL	48	9.42
21000G140	8014846534003	BLUE MASKING TAPE PROFESSIONAL 15 DAYS UVR MM 50 X 50 M WITH FRONT LABEL	36	12.25



Adhesive masking tape for professional and auto bodyworks.  
It resists to 80° c (100°c for half an hour). Solvent adhesive

21000/219	8014846535109	MASKING TAPE CAR 80° C MM25 X 50M SHRINK WRAPPED WITH FRONT LABEL	72	3.72
21000/221	8014846535116	MASKING TAPE CAR 80° C MM30 X 50M SHRINK WRAPPED WITH FRONT LABEL	60	4.38
21000/223	8014846535123	MASKING TAPE CAR 80° C MM38 X 50M SHRINK WRAPPED WITH FRONT LABEL	48	5.45
21000/225	8014846535130	MASKING TAPE CAR 80° C MM50 X 50M SHRINK WRAPPED WITH FRONT LABEL	36	7.04



# GEKO TELO LD

Bache protectrice multifonction en ldpe



100G12	8014846225161	Geko 16 m <sup>2</sup> bâche protectrice multifonction LDPE	GESTOPT-OUT OF RANGE	60	1.95
100G14	8014846225208	Geko 20 m <sup>2</sup> bâche protectrice multifonction LDPE	GESTOPT -OUT OF RANGE	50	2.29
100G300	8014846002700	LDpe COVER SHEET MQ 10 (4X2,5) T/20 150-165 GR CA IN XS POLYBAG		100	1.64
100/301	8014846002717	LDpe COVER SHEET MQ 16 (4x4) T/12 150-165 GR CA IN XS POLYBAG		90	1.75
100G304	8014846002748	LDpe COVER SHEET MQ 20 (5X4) T/20 305-320 GR CA IN XS POLYBAG		50	2.76
100/328	8014846003219	LDpe COVER SHEET MQ 20 (5X4) T/16 235-245 GR CA IN XS POLYBAG		60	2,28

## Info

Protection contre la peinture, l'eau, la poussière et l'umidité.

Résistant, re-utilisable, Économique, Écologique.

Disponible en plusieurs mesures, Épaisseurs, en bobines et comme protection de la blanchisserie contre la pluie, la poudre et la pollution



BESCHERMFOLIE IN KARTON EN PLASTIEK -- FEUILLE DE PROTECTION EN CARTON - PLASTIQUE



F089024

111/72	8014846705786	CARTONE LINED PAPER HAVANA H 1 X 20M	weight 180g/m2	96	15.78
F089081	8015230890811	CARTONE LINED PAPER HAVANA H 1 X 25M	weight 180g/m2	40	24.86
111/75	8014846705793	CARTONE LINED PAPER HAVANA H 1 X 50M	weight 180g/m2	40	30.05
F089052	8033315420289	CARTONE LINED PAPER HAVANA H 1 X 50M	weight 180g/m2	40	30.05
F089084	8015230890842	<b>HYDRO</b> CARTONE LINED PAPER HAVANA H 1 X 25M	weight 180g/m2	40	35.50



111/57	8014846001321	EMME CART PAPER H 1 X 15 M ROLL	weight 240g/m2	64	25.60
111/59	8014846001338	EMME CART PAPER H 1 X 20 M ROLL	weight 240g/m2	24	33.12
111/60	8014846705809	EMME CART PAPER H 1 X 60 M ROLL	weight 240g/m2	12	84.45
111/55	8014846001314	EMME CART PAPER ROLL H1 X 10M	weight 240g/m2	96	17.57



100/210	8014846000188	LDPE MULTIPURPOSE COVER SHEET H 1 M 100 SQM (4 X 25M) 200 MY IN BOBBIN	weight: 18,6kg		186.79
100/202	8014846000133	LDPE MULTIPURPOSE COVER SHEET H 1 M 20 SQM (4 X 5 M) 200 MY IN BOBBIN	weight: 3,72kg		43.65
100/204	8014846000140	LDPE MULTIPURPOSE COVER SHEET H 1 M 40 SQM (4 X 10 M) 200 MY IN BOBBIN	weight: 7,44kg		79.73
100/208	8014846000171	LDPE MULTIPURPOSE COVER SHEET H 1 M 80 SQM (4 X 20 M) 200 MY IN BOBBIN	weight: 14,88kg		151.71

## Geko plastic adhesive tape



**ZELFKLEVENDE TAPE VERBONDEN MET EEN HDPE FILM OF PAPIER  
IDEAAL VOOR AUTO CARROSSERIE - BOUW - PROFESIONEEL EN DIY GEBRUIK**

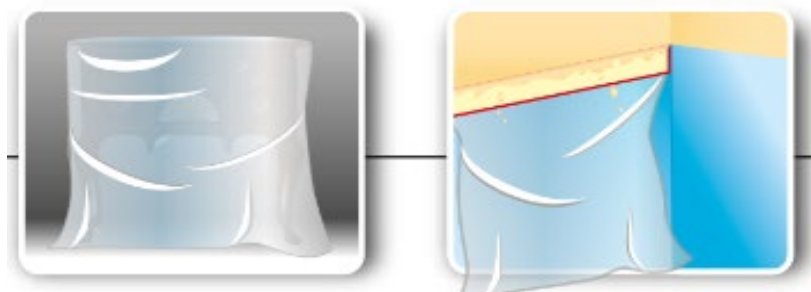

41000/9	8014846670046	DISPENSER A (550 + PAPER 180MM)	1	7.93
41000/11	8014846670053	DISPENSER B (ALL HD + PAPER 300MM)	1	11.14
41000G/1	8014846670008	HD VOORBLAD OP HASPEL MET KLEEFBAND MM1100 X 33M	12	9.96
41000G3	8014846670015	HD VOORBLAD OP HASPEL MET KLEEFBAND MM1400 X 33M	12	11.39
41000G5	8014846670022	HD VOORBLAD OP HASPEL MET KLEEFBAND MM1800 X 20M	12	10.37
41000G7	8014846670039	HD VOORBLAD OP HASPEL MET KLEEFBAND MM2700X16M	12	11.12
41000G13	8014846670060	HD VOORBLAD OP HASPEL MET KLEEFBAND MM550 X 20M	32	4.13
40000G1	8014846660009	PAPIER OP HASPEL MET KLEEFBAND MM100 X 20M	36	3.13
40000G3	8014846660016	PAPIER OP HASPEL MET KLEEFBAND MM180 X 20M	24	3.51
40000G5	8014846660023	PAPIER OP HASPEL MET KLEEFBAND MM300 X 20M	12	4.97

## GEKO - ALU TAPE

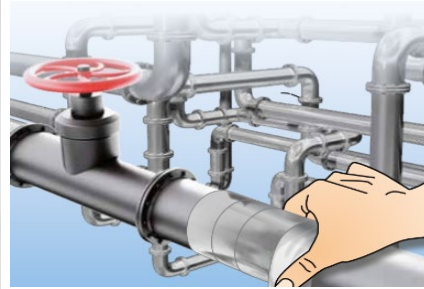

Aluminium acrylic adhesive tape of high thickness.  
Ideal to seal conditioning tubes, pipe insulation and sheets.  
Often used in the refrigeration and heating industry.  
Waterproof and uv ray resistant

30000/4	8014846533617	ALUTAPE -50MM X 50M /30 MY WITH FRONT LABEL	36	16.49
IS30000/4	543000125128	ALUTAPE -50MM X 50M /30 MY WITH SIDE ISTRIX LABEL	24	12,50
30000/9	8014846533600	ALU TOP TAPE -50MM X 50M /50 MY SUPERIEUR STRONG	36	20.30



Metalised plp adhesive tape. It resists temperature of 100°C for half an hour.  
Ideal on metallic surfaces, various pipelines, tubes and insulating panels

30000/20	8014846534614	METALISED TAPE BOPP MM50 X 66M WITH FRONT LABEL	36	6.99
----------	---------------	---	----	------



High temperature resistance - adhesive alum tape mixed colours

				price / pc
230/96	8014846940149	ADH. ALUM.TAPE HIGH TEMP.RESISTANT MM40X9M BLACK IN DISPLAY BOX OF 30 PCS	30	14.12
230/91	8014846940101	ADH.ALUM.TAPE HIGH TEMP.RESISTANT MM40X9M ALUMINIUM IN DISPLAY BOX OF 30 PCS	30	14.12
230/81	8014846940125	ADH.ALUM.TAPE HIGH TEMP.RESISTANT MM40X9M BROWN IN DISPLAY BOX OF 30 PCS	30	14.12
230/86	8014846940118	ADH.ALUM.TAPE HIGH TEMP.RESISTANT MM40X9M WHITE IN DISPLAY BOX OF 30 PCS	30	14.12

# Geko - double sided adhesive tapes



Double sided adhesive tapes of different types.

The version with gauze is ideal for fixing heavy carpets on uneven

floors (geko **double net**); the version in plp is ideal to fix posters or small carpets (geko **double polyp**);

The differentiated adhesive is ideal for fixing moquettes in general (geko **high&low**).

22020/2	8014846530050	<b>DOUBLE POLYP</b> -50 (MM) x 25 (M) TRANSPARENT WITH FRONT LABEL	18	6.44
22020/6	8014846533488	DOUBLE POLYP -50 (MM) x 5 (M) TRANSPARENT WITH FRONT LABEL	36	2.46
22030	8014846533624	<b>DOUBLE NET</b> -50 (MM) x 25 (M) WHITE WITH FRONT LABEL	18	13.91
<b>IS22030</b>	<b>543000125127</b>	<b>DOUBLE NET</b> -50 (MM) x 25 (M) YELLOW WITH SIDE ISTRIX LABEL	<b>24</b>	<b>10,50</b>
22030/3	8014846533686	DOUBLE NET -50 (MM) x 5 (M) WHITE WITH SIDE LABEL	36	3.44
22020/30	8014846533594	<b>DOUBLE HIGH&amp;LOW</b> -50 (MM) x 10 (M) TRANSPARENT WITH FRONT LABEL	36	13.71



the range of small bi-adhesive tapes are useful ad home, office and school



22010/2	8014846530043	BI ADHESIVE GHOST -15 (MM) x 10 (M) TRANSPARENT IN CLOSED BOX	24	3.41
22010	8014846530036	BI ADHESIVE TNT TAPE -15 (MM) x 10 (M) TRANSPARENT IN CLOSED BOX	24	3.45



## Geko -FIX



High thickness double sided adhesive foam tape. Internal and external use

20000/8	8014846532108	BI ADHESIVE FIX IN TAPE -19 (MM) x 10(M) WHITE IN CLOSED BOX	12	9.07
20000/6	8014846532092	BI ADHESIVE FIX IN TAPE -19 (MM) x 5(M) WHITE IN CLOSED BOX	12	5.59
20000/10	8014846532115	BI ADHESIVE FIX IN TAPE -25 (MM) x 5(M) WHITE IN CLOSED BOX	12	6.63



High thickness double sided adhesive foam tape. Internal and external use

20000G14	8014846532139	BI ADHESIVE FIX OUT TAPE -19 (MM) x 5(M) BLACK IN CLOSED BOX	12	7.56
20000G16	8014846532146	BI ADHESIVE FIX OUT TAPE -25 (MM) x 5(M) BLACK IN CLOSED BOX	12	9.10



tot 140kg

For both internal and external use.  
For use in place of nails and screws

20010	8014846532160	DOUBLE SIDED ADHESIVE TAPE EXTRA STRONG 19MM x 1,5M IN CLOSED BOX	24	10.45
-------	---------------	---	----	-------



## Geko - REPAIR

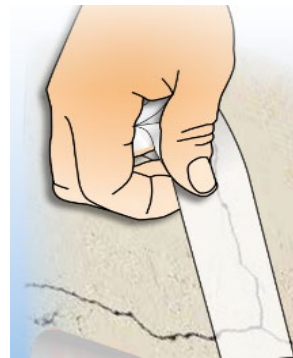

*Adhesive tape used to cover cracks in walls which need to be painted*

21000/202	8014846534317	CRACK REPAIR TAPE MM50 X 10M WITH FRONT LABEL	96	5.35
-----------	---------------	---	----	------

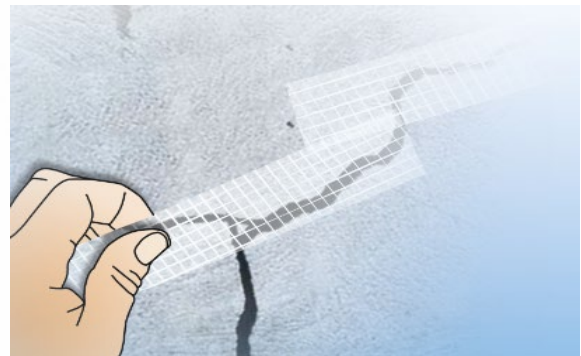

*Adhesive tape ideal for covering large cracks in walls and for joining plasterboards*

31000/4	8014846533655	FIBREGLASS MESH TAPE MM 48 X 45 M WITH SIDE LABEL	20	7.41
IS31000	5430001251227	FIBREGLASS MESH TAPE MM 48 X 50 M WITH SIDE LABEL	24	7.23
31000/6	8014846533716	FIBREGLASS MESH TAPE MM 48 X 90 M WITH SIDE LABEL	16	14.16
31000/2	8014846533662	FIBREGLASS MESH TAPE MM48 X 20M WITH SIDE LABEL	28	4.01

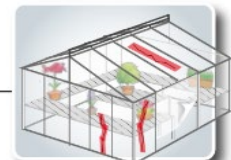

*Ideal to repair glass or polyethylene greenhouses and for polycarbonate sheets*

18000/5	8014846531330	LDPE TAPE MM50 X 30M WITH FRONT LABEL	36	6.20
---------	---------------	---------------------------------------	----	------

## Geko -ADHESIVE TAPES - ALL TYPES



*High thickness. Ideal for joining vapour barriers, attics and for general building works, etc  
Pvc adhesive orange tape*

25000/4	8014846532825	ADHESIVE ORANGE PVC TAPE 50MM X 33M WITH FRONT LABEL	36	8.31
IS25000/4	543000125129	ADHESIVE ORANGE PVC TAPE 50MM X 33M WITH SIDE LABEL	24	6.44
25000/6	8014846532832	ADHESIVE ORANGE PVC TAPE 75MM X 33M WITH FRONT LABEL	24	12.67



*Magnet adhesive tape that can be cut with scissors.  
To be applied to any clean and flat surface by simply removing the protective liner.*

29000/2	8014846534799	MAGNETIC ADHESIVE TAPE MM 19 X 1 M IN BOX	18	7.71
---------	---------------	---	----	------



*Auto-amalgamating tape ideal for the junction for underwater pumps). Useful for grafting plants together*

16000/2	8014846530371	SELF AMALGAMATING TAPE MM 19 X 10 M IN CLOSED BOX	12	12.24
16000	8014846530364	SELF AMALGAMATING TAPE MM25 X 3M IN CLOSED BOX	16	7.80

## ISOLATIETAPE - BANDE ISOLANTE ADHESIVE



**Ruban isolant et ignifuge, idéal pour les commettages de cables électriques.  
Idéal pour l'usage professionnel.**

17000/12	8014846530449	ISOLATION TAPE MM 15 X 10 M RED IN BOX	24	2,55
17000/10	8014846530432	ISOLATION TAPE MM 15 X 10 M BLACK IN BOX	24	2,55
17000	8014846530388	ISOLATION TAPE MM 15 X 10 M BLUE IN BOX	24	2,55
17000/16	8014846530463	ISOLATION TAPE MM 15 X 10 M BROWN IN BOX	24	2,55
17000/2	8014846530395	ISOLATION TAPE MM 15 X 10 M GREEN IN BOX	24	2,55
17000/8	8014846530425	ISOLATION TAPE MM 15 X 10 M GREY IN BOX	24	2,55
17000/4	8014846530401	ISOLATION TAPE MM 15 X 10 M WHITE IN BOX	24	2,55
17000/6	8014846530418	ISOLATION TAPE MM 15 X 10 M YELLOW IN BOX	24	2,55
17000/14	8014846530456	ISOLATION TAPE MM 15 X 10 M YELLOW/GREEN IN BOX	24	2,55
17000/46	8014846530616	ISOLATION TAPE MM 19 X 25 M BLACK IN BOX	18	5,25
17000/36	8014846530562	ISOLATION TAPE MM 19 X 25 M BLUE IN BOX	18	5,25
17000/52	8014846530647	ISOLATION TAPE MM 19 X 25 M BROWN IN BOX	18	5,25
17000/38	8014846530579	ISOLATION TAPE MM 19 X 25 M GREEN IN BOX	18	5,25
17000/44	8014846530609	ISOLATION TAPE MM 19 X 25 M GREY IN BOX	18	5,25
17000/48	8014846530623	ISOLATION TAPE MM 19 X 25 M RED IN BOX	18	5,25
17000/40	8014846530586	ISOLATION TAPE MM 19 X 25 M WHITE IN BOX	18	5,25
17000/42	8014846530593	ISOLATION TAPE MM 19 X 25 M YELLOW IN BOX	18	5,25
17000/50	8014846530630	ISOLATION TAPE MM 19 X 25 M YELLOW/GREEN IN BOX	18	5,25
17000/74	8014846530746	ISOLATION TAPE MM 25 X 25 M BLACK IN BOX	18	5,97
17000/78	8014846530760	ISOLATION TAPE MM 25 X 25 M BLACK SHRINK WRAPPED WITH FRONT LABEL IN TOWER	32	4,33
17000/76	8014846530753	ISOLATION TAPE MM 25 X 25 M WHITE IN BOX	18	5,97
17000/80	8014846530777	ISOLATION TAPE MM 25 X 25 M WHITE SHRINK WRAPPED WITH FRONT LABEL IN TOWER	32	4,33
17000/28	8014846530524	ISOLATION TAPE MM15 X 10M BLACK SHRINK WRAPPED WITH FRONT LABEL IN TOWER	120	1,01
17000/18	8014846530470	ISOLATION TAPE MM15 X 10M BLUE SHRINK WRAPPED WITH FRONT LABEL IN TOWER	120	1,01
17000/34	8014846530555	ISOLATION TAPE MM15 X 10M BROWN SHRINK WRAPPED WITH FRONT LABEL IN TOWER	120	1,01
17000/20	8014846530487	ISOLATION TAPE MM15 X 10M GREEN SHRINK WRAPPED WITH FRONT LABEL IN TOWER	120	1,01
17000/26	8014846530517	ISOLATION TAPE MM15 X 10M GREY SHRINK WRAPPED WITH FRONT LABEL IN TOWER	120	1,01
17000/17	8014846532351	ISOLATION TAPE MM15 X 10M MIX SHRINK WRAPPED WITH FRONT LABEL IN TOWER	120	1,01
17000/30	8014846530531	ISOLATION TAPE MM15 X 10M RED SHRINK WRAPPED WITH FRONT LABEL IN TOWER	120	1,01
17000/22	8014846530494	ISOLATION TAPE MM15 X 10M WHITE SHRINK WRAPPED WITH FRONT LABEL IN TOWER	120	1,01
17000/24	8014846530500	ISOLATION TAPE MM15 X 10M YELLOW SHRINK WRAPPED WITH FRONT LABEL IN TOWER	120	1,01
17000/32	8014846530548	ISOLATION TAPE MM15 X 10M YELLOW/GREEN SHRINK WRAPPED WITH FRONT LABEL	120	1,02
17000/64	8014846530708	ISOLATION TAPE MM19 X 25M BLACK SHRINK WRAPPED WITH FRONT LABEL IN TOWER	50	3,26
17000/54	8014846530654	ISOLATION TAPE MM19 X 25M BLUE SHRINK WRAPPED WITH FRONT LABEL IN TOWER	50	3,26
17000/70	8014846530739	ISOLATION TAPE MM19 X 25M BROWN SHRINK WRAPPED WITH FRONT LABEL IN TOWER	50	3,26
17000/56	8014846530661	ISOLATION TAPE MM19 X 25M GREEN SHRINK WRAPPED WITH FRONT LABEL IN TOWER	50	3,26
17000/62	8014846530692	ISOLATION TAPE MM19 X 25M GREY SHRINK WRAPPED WITH FRONT LABEL IN TOWER	50	3,26
17000/66	8014846530715	ISOLATION TAPE MM19 X 25M RED SHRINK WRAPPED WITH FRONT LABEL IN TOWER	50	3,26
17000/58	8014846530678	ISOLATION TAPE MM19 X 25M WHITE SHRINK WRAPPED WITH FRONT LABEL IN TOWER	50	3,26
17000/60	8014846530685	ISOLATION TAPE MM19 X 25M YELLOW SHRINK WRAPPED WITH FRONT LABEL IN TOWER	50	3,26
17000/68	8014846530722	ISOLATION TAPE MM19 X 25M YELLOW/GREEN SHRINK WRAPPED WITH FRONT LABEL	50	3,31
17000/90	8014846530784	ISOLATION TAPE MM50 X 25M BLACK SHRINK WRAPPED WITH FRONT LABEL IN TOWER	20	8,62
17000/92	8014846530791	ISOLATION TAPE MM50 X 25M WHITE SHRINK WRAPPED WITH FRONT LABEL IN TOWER	20	8,62

## Geko - TEFLON - SILICONE



Teflon tape for professional and diy plumbing

7800/8	8014846534867	P.T.F.E. THREAD SEAL TAPE GAS <b>YELLOW</b> MM 12 X 12 M BULK (WITH EAN)	250	2.05
7800/5	8014846534836	P.T.F.E. THREAD SEAL TAPE PROFESSIONAL <b>WHITE</b> MM 19 X 15 M (100MY) BULK WITH EAN	250	4.09
7800/6	8014846534812	P.T.F.E. THREAD SEAL TAPE WHITE MM12 X 12M BULK (EAN CODE) MADE IN P.R.C.	200	0.93



42000/1	8014846545238	HIGH TEMPERATURE RESISTANT SELF AMLAGAMATING SILICONE TAPE MM25 X 3M IN CLOSED BOX WITH DISPLAY	12	21.44
---------	---------------	---	----	-------



# GEKO SANY

## Lijmkit - Joint d'étanchéité



Voor badkuip, douchevloer, gootsteen, gootsteen, camper en caravans.  
 Waterdicht, reukloos, eenvoudig te installeren, verwijderbaar en herbruikbaar.  
 Beschermt tegen onzuiverheden en bacteriën.  
 Beschikbaar in blisterverpakking van acetaat. Kleuren: wit  
 Pour baignoires, planchers des douches, lavabos  
 et éviers dans la maison et aussi dans les roulottes.  
 Facile à installer. Amovible et re-utilisable.  
 Il protège contre l'impureté et les bactéries.  
 Blister acétate. Coloris: blanc

450/1	8014846002403	mm 22 x 2,4 m, white, in double blister with Geko brand label	50	8.39
-------	---------------	---	----	------

## pvc-pakking voor speelbakken - joint en pvc pour les éviers



Vereist om alle infiltratie tussen de muur en de gootsteen te elimineren.  
 Drukmontage eenvoudig bewerking  
 Verkrijgbaar in de maten 130 cm of 200 cm in zelfbedieningsverpakking  
 of op rollen van 25 m. Kleuren: wit-transparant  
 Idéal pour éliminer les infiltrations entre le mur  
 Installation et déplacement très facile  
 Mesure: cm 130 et cm 200 en boîte ou rouleau de cm 25  
 Coloris: blanc et transparent

400/6	8014846001307	cm 130, white, in closed box Geko brand	18	7.13
400/8	8014846002021	cm 130, transparent, in closed box Geko brand	18	7.13
400/10	8014846002007	cm 200, white, in closed box Geko brand	18	10.44
400/12	8014846002038	cm 200, transparent, in closed box Geko brand	18	10.44



## Geko - BI-METALLIC TAPES



Thanks to its shining reflections and sound effects protects from the damages caused by birds, wild animals as wild boars, badgers and rodents.  
Particularly indicated for fruit trees, cultivation, eaves, balconies, fishing boats and pleasure- boats.

240/10	8014846960024	mm 70 x 100 m, gold/silver, in closed box Geko brand	24	9.56
--------	---------------	--	----	------



Ribbon for christmas decoration, parties and special occasions

270	8014846960031	mm 70 x 100 m, gold/silver, in closed box Geko brand	24	9.56
-----	---------------	--	----	------

## Geko - DOORSTRIPS



*Double sided draught excluder for the bottom of the door*

1470	8014846259500	95 cm, grey, in printed polybag Geko brand	60	9.55
1470/4	8014846259524	95 cm, white, in printed polybag Geko brand	60	10.11
1470/2	8014846259517	95 cm, brown, in printed polybag Geko brand	60	10.11
1470G9	8014846259548	95 cm, mixed colours - 60 pcs - in printed polybag Geko brand	1	606.76



*Adhesive draught excluder in pvc foam for the bottom of the door  
bas de porte adhésif 1m en mousse de pvc*

1400G21	8014846009105	mm 28 X 100 cm, transparent, in closed box Geko brand	24	4.16
1400G20	8014846000928	mm 38 X 100 cm, white, in closed box Geko brand	24	3.73
1400G18	8014846000935	mm 38 X 100 cm, brown, in closed box Geko brand	24	4.01

# Geko - BAS DE PORTE ADHESIF

## ZELFKLEVENDE DORPELSTRIP MET BORSTEL

## BAS DE PORTE ADHESIF EN PVC RIGIDE AVEC BROSSE

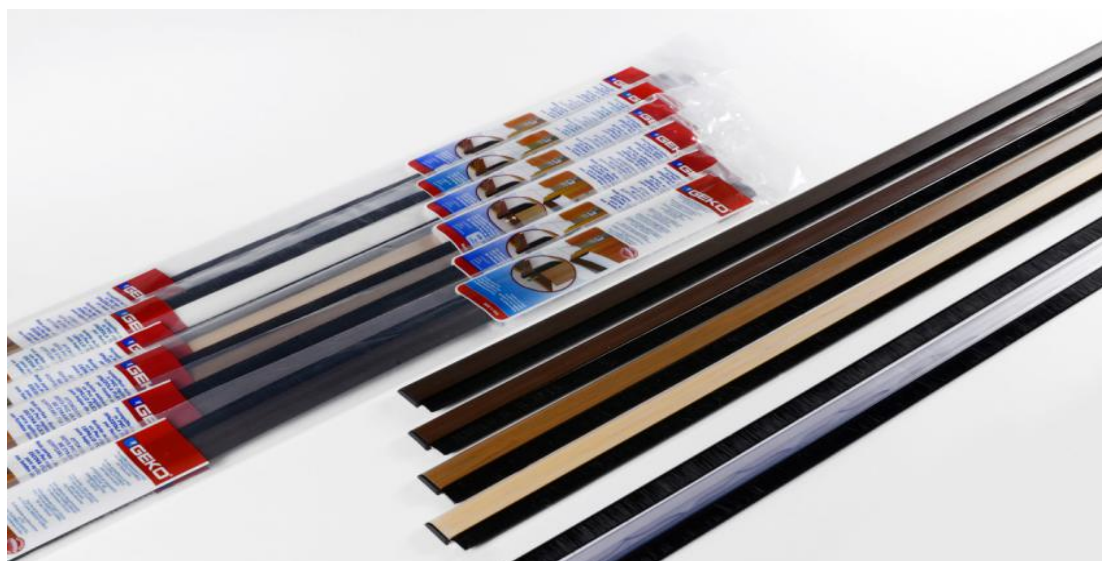

### Adhesive draught excluder in **rigid PVC with brush** for the bottom of the door

1400G4	8014846000997	100 cm, white, in printed polybag Geko brand	25	4.91
1400G2	8014846000980	100 cm, brown, in printed polybag Geko brand	25	4.91
1400G5	8014846000973	100 cm, transparent, in printed polybag Geko brand	25	5.18
1400/22	8014846000805	100 cm, wood imitation (mahogany), in printed polybag Geko brand	25	5.70
1400/26	8014846000829	100 cm, wood imitation (pine), in printed polybag Geko brand	25	5.70
1400/24	8014846000812	100 cm, wood imitation (walnut), in printed polybag Geko brand	25	5.70

### Adhesive draught excluder in **rigid PVC with flexible brush** for the bottom of the door

1460G01	8014846259005	100 cm, white, in printed polybag Geko brand	12	10.73
1460G02	8014846259012	100 cm, brown, in printed polybag Geko brand	12	10.73
1460G03	8014846259029	100 cm, transparent, in printed polybag Geko brand	12	11.27
1460/04	8014846259036	100 cm, wood imitation (mahogany), in printed polybag Geko brand	12	11.54
1460/06	8014846259050	100 cm, wood imitation (pine), in printed polybag Geko brand	12	11.54
1460/05	8014846259043	100 cm, wood imitation (walnut), in printed polybag Geko brand	12	11.54

### Adhesive draught excluder in **aluminium with brush** for the bottom of the door, for uneven surfaces

1400/12	8014846000966	100 cm, white, in printed polybag Geko brand	12	11.70
1400/10	8014846000959	100 cm, brown, in printed polybag Geko brand	12	11.70



*flexible brush*

### Adhesive draught excluder in **aluminium with flexible brush** for the bottom of the door, for uneven surfaces

1400/16	8014846000904	100 cm, white, in printed polybag Geko brand	12	19,98
1400/14	8014846000911	100 cm, brown, in printed polybag Geko brand	12	19,98



## Geko - adhesive draught excluder tochtstrips - bande d'étanchéité



### GEKO SOUND-THERM Adhesive sound and draught excluder for internal and external doors and windows

3300/2	8014846200199	6m (2X3M), white, closed box Geko brand	12	6.88
3300/4	8014846200205	6m (2X3M), brown, closed box Geko brand	12	6.88



### GEKO UNIVERSAL EVO - Adhesive thermoplastic gasket for doors and windows (it fits all gaps, from 1mm to 7mm)

2800G8	8014846600067	mm 9 x 7 x 6 m (2 X 3 m), white, closed box Geko brand	12	9.16
2800G10	8014846600074	mm 9 x 7 x 6 m (2 X 3 m), transparent, closed box Geko brand	12	9.16
2800G12	8014846600081	mm 9 x 7 x 6 m (2 X 3 m), brown, closed box Geko brand	12	9.16

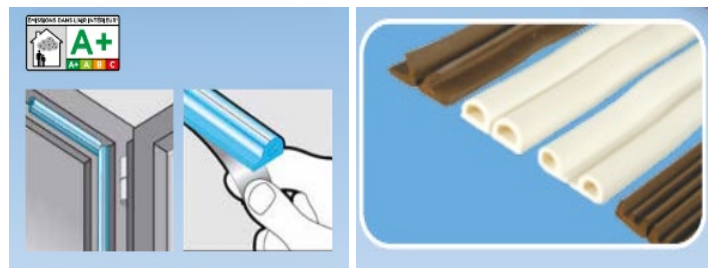

### GEKO STRIP - Adhesive draught excluder in extruded EPDM rubber for doors and windows

1000G5	8014846100123	PROFILE E - mm 9 x 4 x 6 m (2 X 3 m), white, closed box Geko brand	12	3.57
1000G3	8014846100116	PROFILE E - mm 9 x 4 x 6 m (2 X 3 m), brown, closed box Geko brand	12	3.57
1000G9	8014846200120	PROFILE P - mm 9 x 5,5 x 6 m (2 X 3 m), white, closed box Geko brand	12	3.70
1000G7	8014846200113	PROFILE P - mm 9 x 5,5 x 6 m (2 X 3 m), brown, closed box Geko brand	12	3.70
1000G66	8014846620034	PROFILE D - mm 9 x 6 x 6 m (2 X 3 m), white, closed box Geko brand	12	4.04
1000G64	8014846620027	PROFILE D - mm 9 x 6 x 6 m (2 X 3 m), brown, closed box Geko brand	12	4.04

# Geko - adhesive draught excluder

## Tochtstrips - bande d'étanchéité



GEKO FLEX - Adhesive draught excluder in PVC foam for doors and windows				
1200G7	8014846300110	PROFILE I - mm 9 x 3 x 6 m (2 X 3 m), white, closed box Geko brand	12	3.03
1200G9	8014846300219	PROFILE I - mm 9 x 3 x 6 m (2 X 3 m), brown, closed box Geko brand	12	3.03



GEKO STIK - Adhesive foam draught excluder for doors and windows				
1100/2	8014846001086	mm 10 x 6 x 8 m, white, in printed polybag Geko brand	50	1.74
1100/4	8014846001543	mm 15 x 6 x 4 m, white, in printed polybag Geko brand	68	1.61
1100/12	8014846001581	mm 15 x 6 x 8 m, white, in printed polybag Geko brand	34	2.41
1100/14	8014846002083	mm 20 x 6 x 8 m, white, in printed polybag Geko brand	25	2.88
1100/16	8014846002588	mm 25 x 6 x 8 m, white, in printed polybag Geko brand	20	3.31



GEKO GARAGE - Multi-purpose adhesive foam sealing gasket of high thickness				
1100/51	8014846176500	mm 17 x 17 x 6,5 mt (2X3,25), grey, in printed polybag Geko brand	20	4.83



**Joint adhésif en polypropylène pour portes et fenêtres coulissantes.**  
 Il calfeutre contre le froid, protège des courants d'air et de l'humidité, économisant l'énergie. Durée moyenne : <= 8 ans. De grande flexibilité.  
 Rapide et facile à appliquer.  
 Coloris: transparent

GEKO V - Special adhesive sealing strip in polypropylene for sliding doors and windows				
2000/6	8014846300301	mm 22 x 10 m, transparent, in double blister with Geko label	30	13.18



## Geko - VARIA



**Panneau réfléchissant de la chaleur en résine de polyéthylène jointe à une feuille recouverte d'aluminium avec une surface embossée.**  
Dimensions: cm 70 x 100.  
Disponible même en rouleau de cm 100 x 20 m

### GEKO REFLEX - Heat reflecting panel in PE resin, joined to an aluminium film with embossed surface

1600G2	8014846110016	cm 70 X 100 cm, aluminium colour, in polybag with Geko brand label	40	8.34
--------	---------------	--	----	------



**Filtres spéciaux pour air conditionné et climatiseurs. Filtre noir à charbon actifs, filtre et neutralise les odeurs.**

### GEKO SPLIT - Universal air conditioning filters

660G	8014846500053	cm 33 x 80 cm, white, in polybag with Geko brand label	24	5.39
660/2	8014846500046	cm 50 x 75 cm, black (active carbons), in polybag with Geko brand label	24	10.09

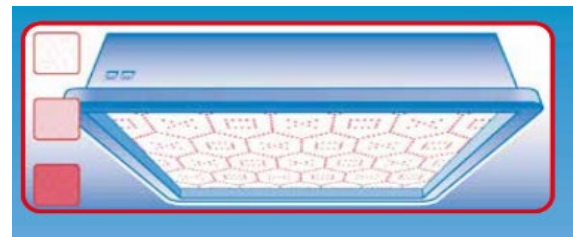

**Filtre pour les hottes d'aspiration avec une capacité filtrante très élevée.**

Il devient de coloris rouge quand on doit le remplacer.  
Coloris: blanc

### GEKO CAMAL - Filter for extractor hoods

770G	8014846501029	cm 50 x 100 cm in polybag Geko brand	20	6.74
------	---------------	--------------------------------------	----	------

## Geko - anti-bump adhesive pads + display



Adhesive anti-bump pads (to be placed on the walls of the garage to prevent collisions with the rear bumper and side doors opening)				
1810/05	8014846001048	LARGE - cm 24 x 50 cm, white/red, set of n. 2 pcs in polybag with Geko brand label	15	11.31
1810/07	8014846001055	LONG - cm 13.7 x 100 cm, white/red, set of n. 2 pcs in polybag with Geko brand label	8	13.38
1810	8014846001017	STANDARD - cm 13,7 x 50 cm, white/red, set of n. 2 pcs in polybag with Geko brand label	15	7.12
1810/11	8014846001093	STANDARD - cm 13,7 x 50 cm, white/red, set of n. 4 pcs in polybag with Geko brand label	8	10.24
1810/01	8014846001024	JOLLY MEDIUM - cm 32 x 40 cm, white/red, in polybag with Geko brand label	10	12.95
1810/03	8014846001031	JOLLY SMALL - cm 20 x 30 cm, white/red, in polybag with Geko brand label	12	7.51



1810G20	8014846970009	<b>GEKO BOX Mixed display of n. 35 pcs (CONTENTS BELOW) adhesive anti bump pads mixed</b>	1	366.32
---------	---------------	---	---	--------

**GEKO BOX** - Adhesive anti-bump pads (to be placed on the walls of the garage to prevent collisions with the rear bumper and side doors opening)

1810/05	8014846001048	LARGE - cm 24 x 50 cm, white/red, set of n. 2 pcs in polybag with Geko brand label	PC	2
1810/07	8014846001055	LONG - cm 13.7 x 100 cm, white/red, set of n. 2 pcs in polybag with Geko brand label	PC	3
1810	8014846001017	STANDARD - cm 13,7 x 50 cm, white/red, set of n. 2 pcs in polybag with Geko brand label	PC	12
1810/01	8014846001024	JOLLY MEDIUM - cm 32 x 40 cm, white/red, in polybag with Geko brand label	PC	6
1810/03	8014846001031	JOLLY SMALL - cm 32 x 40 cm, white/red, in polybag with Geko brand label	PC	10
1810/09	8014846001062	cm 63 x 63 cm, black, with Geko brand label	PC	2
				pcs = 35

## Geko - Adhesive acoustic tape



**Joint EPDM multifonction avec adhésif toilé.**  
 Professionnel, diélectrique, résistant aux huiles et aux intempéries.  
 Haute adhérence et longue durée.



GEKO D13000 - Self-adhesive EPDM multipurpose gasket, with net adhesive (TOP QUALITY)				
3000G	8014846103223	mm 10 x 3 x 20 m, black, in polybag with Geko label	36	8.12
3000G2	8014846103230	mm 10 x 5 x 15 m, black, in polybag with Geko label	36	8.93
3000G4	8014846103247	mm 15 x 10 x 10 m, black, in polybag with Geko label	25	14.34
3000G8	8014846103261	mm 15 x 5 x 15 m, black, in polybag with Geko label	25	11.91
3000G10	8014846103278	mm 20 x 10 x 10 m, black, in polybag with Geko label	20	18.16
3000G14	8014846103292	mm 20 x 5 x 15 m, black, in polybag with Geko label	16	15.51
3000G16	8014846103308	mm 25 x 10 x 10 m, black, in polybag with Geko label	16	22.20
3000G18	8014846103315	mm 25 x 5 x 15 m, black, in polybag with Geko label	16	19.22
3000G20	8014846103322	mm 30 x 10 x 10 m, black, in polybag with Geko label	12	26.25
3000G24	8014846103346	mm 30 x 5 x 15 m, black, in polybag with Geko label	12	22.65

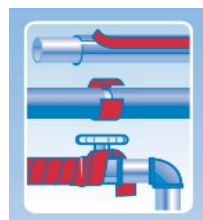

**Joint adhésif** en matériel imperméable à cellules fermées, anti-condensation, antigel, pur l'isolation thermique et acoustique. Idéale pour calfeutrer les tuyaux de chauffage et les vannes, pour sceller les cache-tuyaux après la pose et pour éviter les infiltrations d'eau et d'air en général

GEKO TERM - Adhesive thermo acoustic sealing gasket				
2600G16	8014846050206	mm 25 x 3 x 5 m, grey, in closed box Geko brand	12	5.41
2600G	8014846050107	mm 50 x 3 x 10 m, grey, in printed polybag Geko brand	36	9.55
2600G18	8014846050213	mm 50 x 3 x 5 m, grey, in polybag with Geko brand label	12	7.39

## Geko - multi purpose panel



**Panneau Multifonction** à utiliser pour protéger des chocs, pour éviter les vibrations ou comme panneau de confort pour petits travaux de bricolage.

### GEKO MULTI - Multipurpose panel

1810G09	8014846001062	cm 63 x 63 cm, black, with Geko brand label	6	13.38
---------	---------------	---	---	-------



### GEKO FLOOR - High absorbant felt joined to a PE film

111/45	8014846001345	m 1 x 3 m, in polybag with Geko label	6	12.31
111/46	8014846001413	m 1 x 4 m, in polybag with Geko label	5	15.12
111/47	8014846001420	m 1 x 25 m, in big roll	6	59.00
111/49	8014846001444	m 1 x 10m, in big roll	6	24.84

#### **Feutre joint à une feuille de polyéthylène.**

Il protège le carrelage, le parquet et des autres surfaces contre la peinture et contre la chute accidentelle des objets.

Très absorbant, lavable, on peut le plier et re-utiliser plusieurs fois.



## Geko - zelfklevend /adhesive tapes



GEKO TERM F1 - Self-adhesive nitrile rubber (self-extinguishing class F1)				
2600/8	8014846800092	mm 50 x 3 x 5 m, black, in polybag with Geko brand label	12	8.20

**Joint caoutchouc nitrile** à cellules fermées, Anti-condensation, antigel, pour l'isolation thermique et acoustique. Idéal pour calfeutrer les tuyaux de chauffage et les vannes, pour sceller les cache-tuyaux après la pose et pour éviter les infiltrations d'eau e d'air en général. Auto-extinguible classe F1



GEKO PRESS - Self-adhesive pre-compressed expanded foam gasket				
910	8014846050114	mm 10 x 10 x 10 m, grey, in polybag with Geko brand label	20	11.15
910/2	8014846050121	mm 20 x 20 x 6 m, grey, in polybag with Geko brand label	18	21.76
910/4	8014846050138	mm 30 x 25 x 5 m, grey, in polybag with Geko brand label	12	30.78

### Mousse comprimée.

Pour l'étanchéité à l'air et à l'eau des joints de menuiserie et de façade. Résistant aux températures extrêmes (-40 ° C / + 140 ° C). Une fois fixée la mousse se décompresse pour sceller, étanchéifier et combler les défauts ainsi que les irrégularités.



GEKO FIX - Single-sided adhesive polyethylene tape with closed cells (ideal for fixing frameworks for walls in plasterboard).				
2900G22	8014846920103	mm 25 x 3 x 20 m, grey, in bulk	26	6.29
2900G24	8014846920110	mm 30 x 3 x 20 m, grey, in bulk	22	7.67
2900G26	8014846920127	mm 40 x 3 x 20 m, grey, in bulk	16	10.48
2900G28	8014846920134	mm 50 x 3 x 20 m, grey, in bulk	13	12.90

**Bande en polyéthylène.** Ruban Simple face (FIX) et ruban double face (DOUBLE FIX), adhésif en polyéthylène à cellule fermée idéale pour fixer les rails de support pour les cloisons en Placoplatre , pour usage domestique et industriel.



## GEKO - ACOUSTIC



It also protects against insects, parasites and moulds.  
Useful in case of irregular surfaces. High stability over time. Available in versions joined to an aluminized film or to an hd film which gives an anti-condensation benefit.

1701/01	8014846100826	ALUMINIUM WOOD FLOOR UNDERLAY 1 X 15 M, THICKNESS MM 2 IN POLYBAG	6	65.30
---------	---------------	---	---	-------

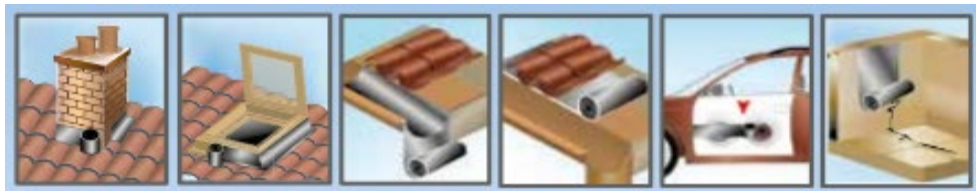

**Ruban adhésif en bitume joint à un film d'aluminium.**

Très résistant à l'eau, il est idéal pour imperméabiliser les gouttières, les cheminées et les fissures en général.

Disponible en différentes largeurs.

Highly watertight, particularly indicated to waterproof gutters, chimneys and waterproof gutters, chimneys and different kind of cracks. Available in different width.

2500/4	8014846100109	mm 100 x 10 m, aluminium, in shrinked film with Geko brand labels	6	34.80
2500/6	8014846150104	mm 150 x 10 m, aluminium, in shrinked film with Geko brand labels	4	50.09
2500/7	8014846200014	mm 200 x 10 m, aluminium, in shrinked film with Geko brand labels	3	65.37
2500/8	8014846225017	mm 225 x 10 m, aluminium, in shrinked film with Geko brand labels	2	72.96
2500/10	8014846300011	mm 300 x 10 m, aluminium, in shrinked film with Geko brand labels	2	95.83
2500/5	8014846450006	mm 450 x 10 m, aluminium, in shrinked film with Geko brand labels	1	143.75
2500/2	8014846005107	mm 50 x 10 m, aluminium, in shrinked film with Geko brand labels	12	20.38
2500/9	8014846500015	mm 500 x 10 m, aluminium, in shrinked film with Geko brand labels	1	159.68
2500/3	8014846075100	mm 75 x 10 m, aluminium, in shrinked film with Geko brand labels	8	27.64

## GEKO afvalzak voor bouwafval - construction de sacs à ordures



50070/2	8014846720185	RUBBLE SACK LDPE 120 MY 40 X 70 CM 25 L 61 GR CA AMBER IN ROLL 10 PCS	RL	20	960	6.00
50070/3	8014846720192	RUBBLE SACK LDPE 120 MY 50 X 80 CM 45 L 86 GR CA AMBER IN ROLL 10 PCS	RL	15	780	8.06
50070/1	8014846720178	RUBBLE SACK LDPE 90 MY 40 X 70 CM 25 L 46 GR CA AMBER IN ROLL 10 PCS	RL	30	1440	4.74





## DISPLAY TOONBANK ANTI-SLIP TAPES



220G57	ANTISLIP TAPE + ANTISKID TAPE MM25 X 5M IN BOX - IN TABLETOP DISPLAY OF 36PCS.	357.30
--------	--	--------

220G56	GEKO ADHESIVE ANTI-SKIP TAPE MM25X5M TRANSPARENT	6
220G52	GEKO ADHESIVE ANTI-SLIP TAPE MM 25 X 5 M BLACK	6
220G55	GEKO ADHESIVE ANTI-SLIP TAPE MM 25 X 5 M YELLOW/BL	6
220G54	GEKO ADHESIVE ANTI-SLIP TAPE MM25X5M TRANSPARENT	6
220G58	GEKO ANTISLIP TAPE MM 25 X 5 M FLUO	6
220G53	GEKO ADHESIVE ANTI-SLIP TAPE MM 25 X 5 M WIT/BLANC	6

## GEKO BOX MIX - ANTI -BUMP

GEKO BOX MIX - Adhesive anti-bump pads (in display)					PRICE BRUT €
1810G20	8014846970009		Mixed display of n. 35 pcs (CONTENTS BELOW)	PC	366.32
<b>GEKO BOX - Adhesive anti-bump pads (to be placed on the walls of the garage to prevent collisions with the rear bumper and side doors opening)</b>					<b>QUANTITY IN CARTON</b>
1810/05	8014846001048		LARGE - cm 24 x 50 cm, white/red, set of n. 2 pcs in polybag with Geko brand label	PC	2
1810/07	8014846001055		LONG - cm 13,7 x 100 cm, white/red, set of n. 2 pcs in polybag with Geko brand label	PC	3
1810	8014846001017		STANDARD - cm 13,7 x 50 cm, white/red, set of n. 2 pcs in polybag with Geko brand label	PC	12
<b>GEKO BOX JOLLY - Adhesive anti-bump PRE-CUTTED pads (to be placed on round surfaces or pillars)</b>					<b>QUANTITY IN CARTON</b>
1810/01	8014846001024		JOLLY MEDIUM - cm 32 x 40 cm, white/red, in polybag with Geko brand label	PC	6
1810/03	8014846001031		JOLLY SMALL - cm 32 x 40 cm, white/red, in polybag with Geko brand label	PC	10
<b>GEKO MULTI - Multipurpose panel</b>					<b>QUANTITY IN CARTON</b>
1810/09	8014846001062		cm 63 x 63 cm, black, with Geko brand label	PC	2
TOTAL DISPLAY PCS					<b>35</b>





# BIODUR<sup>®</sup> NATURAL DURABILITY

## BIODUR UNIVERSAL ENAMEL



### Application

Used for painting, restoration, decoration on a various surfaces. Perfect for stencil-plates. For indoor and outdoor use.

### Advantages

Makes a strong coat resistant to mechanic and weather exposure. Has high adhesion rate and increased covering capacity. Does not fade out in the sunlight. Colors correspond with European classification RAL.

### Chemical base

Alkyd enamel strengthened with acrylates.

### Spreading capacity

(depending on coat thickness) is — 1.5-2.0 m<sup>2</sup>.

### Drying time

7-10 min at 25°C.

7.40 €

### Surfaces

Metal, concrete, plasterboard, timber, glass, paper etc.

### Peculiarities

BIODUR Universal line offers both glossy colors (gloss rank up to 95%) and matte colors that has nice velvet effect.

**VOLUME:  
400 ml**

RAL 1001 Beige	RAL 1015 Ivory	RAL 1016 Lemon-yellow	RAL 1023 Yellow	RAL 1028 Yellow melon	RAL 2004 Orange	RAL 3000 Flame red	RAL 3002 Dark red	RAL 3005 Dark cherry
RAL 3011 Cherry	RAL 3020 Red	RAL 4003 Pink	RAL 4005 Violet	RAL 5002 Blue	RAL 5010 Regular blue	RAL 5015 Light blue	RAL 5021 Aqua	RAL 5022 Dark blue
RAL 6005 Dark green	RAL 6006 Khaki olive	RAL 6010 Light green	RAL 6018 Lettuce green	RAL 6029 Green	RAL 7016 Anthracite grey	RAL 7016 Anthracite grey matt	RAL 7024 Dark grey	RAL 7035 Light grey
RAL 7046 Grey	RAL 8011 Brown	RAL 8017 Dark brown	RAL 8017 Dark brown matt	RAL 9003 Snow-white	RAL 9005 Black	RAL 9005 Black satin	RAL 9005 Black matt	RAL 9006 Silver
RAL 9010 White	RAL 9010 White satin	RAL 9010 White matt	RAL 9022 Dark silver	RAL 1036 Dark gold	RAL 3050 Light gold	Antic gold	Bronze	Copper
Gold 24K								

## BIODUR UNIVERSAL LACQUER



### Application

Used for protection of paint coats from mechanic and weather exposure. Makes a strong transparent gloss or matte coat. The unique property of the lacquer is to enrich any color. For indoor and outdoor use.

### Advantages

Increase durability of the final surface at 20%. Does not fade out in the sunlight.

### Chemical base

Acrylic lacquer.

### Spreading capacity

1,0 – 1,5 m<sup>2</sup>.

### Drying time

7-10 min at 25°C.

7.40 €



Gloss



Matt

### Surfaces

Metal, concrete, plasterboard, timber, glass, paper etc.

### Peculiarities

Can be applied as finish coating or independently. To obtain nice smooth effect lacquer has to be applied not later than 30 min. after last enamel layer was applied.

**VOLUME:  
400 ml**

## BIODUR PRIMER UNIVERSAL



### Application

Used for various surface preparation. For indoor and outdoor use.

### Advantages

Smooths the surface, fill cavities and gaps, increase adhesion, reduces paint consumption on 30%, protecting the metal from corrosion.

### Chemical base

Alkyd primer.

### Spreading capacity

1.5-2.0 m<sup>2</sup>.

### Drying time

10-15 min at t 25°C.

7.40 €



White



Grey



Red



Black

### Surfaces

Used before painting metal, timber, concrete, plasterboard and other surfaces.

### Peculiarities

Various colors allows to choose the most suitable option for future painting.

**VOLUME:**  
**400 ml**

## BIODUR HEAT-RESISTANT ENAMEL



### Application

Used for decorative coating and anti-rust protection of metal surfaces that exposed high temperatures influences. For indoor and outdoor use. Primer coat and lacquer must not be applied as it can not resist high temperatures.

### Advantages

Withstands temperatures up to +600°C (depending on enamel color)

### Chemical base

High quality elastic enamel based on silicon organic resins.

### Spreading capacity

1,2-2,0 m<sup>2</sup>.

### Drying time

7-10 min at temperature +25°C.

11.25 €



Black



White



Gold



Silver



Red

### Surfaces

Ovens, boilers, fireplaces, cauldrons, radiators, supports, engines, exhaustion pipes, and industrial equipment.

### Peculiarities

The enamel gains its properties after the first heating to +180-200°C within 15 min. Before this the enamel might peel off. For the black and the silver one the short-term heating temperature (up to 4 hours) +600°C, the long-term heating temperature +400°C. For the other colors the short-term heating temperature +400°C, the long term 200°C.

**VOLUME:**  
**400 ml**

## BIODUR SUPER CHROME ENAMEL



### Application

Used for restoration and decorative painting of products made from metal, timber, glass, ceramics, some kinds of plastic. Makes decorative coating that has "mirror" gloss effect. For indoor use ONLY.

### Advantages

High reflective properties due to the "mirror" chrome effect.

### Chemical base

Acrylic enamel

### Spreading capacity

2,0-2,5 m<sup>2</sup>.

### Drying time

7-10 min at t +25°C.

11.25 €



Gold



Silver

### Surfaces

Widely used for painting pieces of art and furnishings: picture frames, emblems, cups, parts of light units, statues, candle sticks, icons.

### Peculiarities

Used for decoration indoor surfaces.

**VOLUME:**  
**400 ml**

## BIODUR FLUORESCENT ENAMEL



### Application

Used for advert signs, street signs, different kinds of marking. Can also be used for bright household, club, bar design. For indoor and outdoor use.

### Advantages

Highly bright colors. Possible to receive matte or gloss effect applying needed lacquer.

### Chemical base

Acrylic enamel

### Spreading capacity

1,0-1,2 m<sup>2</sup>.

### Drying time

7-10 min at t +25°C.

12.69 €



RAL 0096  
Pink



RAL 1026  
Yellow



RAL 3024  
Orange



RAL 3026  
Red



RAL 5016  
Blue



RAL 9015  
Green

### Surfaces

Metal, concrete, plasterboard, timber, glass, paper and other surfaces covered with white primer.

### Peculiarities

Does not recommended to use on a surfaces that exposed direct sunlight. Does not glow in the dark and does not reflect light.

**VOLUME:**  
**400 ml**

## BIODUR ZINC PRIMER



### Application

Used for anti-rust protection all types of metal and welds. For indoor and outdoor use.

### Advantages

3 in 1 primer – protecting against rust, priming, has decorative effect, petrol-oil-solvent- salt solution resistant. Has high adhesion rate to non-ferrous metals. Withstands temperatures up to +400°C.

### Chemical base

Epoxy ester prime, 98% fine zinc.

### Spreading capacity

1,5-2,0 m<sup>2</sup>.

### Drying time

10-15 min at t +25°C.

10.00 €



Zinc

### Surfaces

Metal constructions, pipes, wrought pieces, hydro technical constructions, pumping and tank equipment, automobile, sea and river transport.

### Peculiarities

Used as primer for paints or independently. If subsequent staining is necessary enamel has to be applied not later than 30 min after priming.

**VOLUME:**  
**400 ml**

## BIODUR ALUMINUM-ZINC ENAMEL



### Application

Used for anti-corrosion treatment of galvanized surfaces, products made of steel, aluminum, ferrous and non-ferrous metals. Enamel with high content of zinc and aluminum powder. For indoor and outdoor use.

### Advantages

Creates a strong protective coating in places of fixing, welding, drilling, cutting. Forms a strong glossy coating, resistant to atmospheric and mechanical influences, oils, saline solutions, temperature fluctuations. Withstands temperature from +250°C (constant effect) to +350°C (not more than 2 hours).

### Chemical base

Acrylic resin with silicon compounds

### Spreading capacity

1,3 – 1,7 m<sup>2</sup>.

### Drying time

10-15 min at t +25°C.

10.00 €



Alu-Zinc

### Surfaces

Roof repair, galvanized profile, drains, drainage, fences, ventilation systems, air conditioning and pipelines, car body restoration and exhaust system.

### Peculiarities

Provide with long cathode protection against rust. Guarantees high electrical conductivity.

**VOLUME:**  
**400 ml**

## BIODUR ALUMINUM ENAMEL



### Application

Used for protection, restoration, decorative painting. Protects metal from corrosion. Contains finely divided aluminum of high purification (99.5%). For indoor and outdoor use.

### Advantages

Forms a strong, glossy coating with an aluminum luster, resistant to gasoline, oils, saline solutions, to abrasion, temperature fluctuations, mechanical and atmospheric influences. Withstands temperatures from +300°C (constant exposure) to +500°C (up to 2 hours).

### Chemical base

Acrylic resin with silicon compounds.

### Spreading capacity

1,3 – 1,7 m<sup>2</sup>.

### Drying time

10-15 min at t +25°C.

10.00 €



Aluminium

### Surfaces

Metal, wood, glass, brick, concrete, plastic, etc.

### Peculiarities

Can be used for decorative works, modeling, hobbies, staining of products from ferrous and nonferrous metals - climatic systems, chimneys, fireplaces, boilers, radiators, tanks, drying ovens, fences, elements of car exhaust systems.

**VOLUME:  
400 ml**

## BIODUR ENAMEL FOR CERAMICS



### Application

Used for restoration and painting, decoration, refurbishing various objects made from from faïence and ceramics. For indoor and outdoor use.

### Advantages

Withstands temperatures up to +100°C. Resistant to washing substances and temperature changes.

### Chemical base

Alkyd enamel.

### Spreading capacity

1,2-1,5 m<sup>2</sup>.

### Drying time

6 hours at +25°C.

8.13 €



White

### Surfaces

Bath tubs (including acrylic), wash basins, sinks, bidets, toilets, shower cubicles, ceramic tiles and other products from faïence and ceramics.

### Peculiarities

Do not prime the surface. Do not apply lacquer on the enamel. The surface will be ready to usage after 48 hours.

**VOLUME:  
400 ml**

## BIODUR ENAMEL FOR DOMESTIC APPLIANCES (AGD)



### Application

Used for restoration and painting the outsides of domestic appliances. For indoor and outdoor use.

### Advantages

Withstands temperatures up to +100°C. Resistant to washing substances and temperature changes.

### Chemical base

Alkyd enamel.

### Spreading capacity

1,2-1,5 m<sup>2</sup>.

### Drying time

6 hours at +25°C.

8.13 €



White

### Surfaces

Fridges, freezers, washing machines, drying drums, microwave ovens, air extractors etc.

### Peculiarities

For safety reasons, it is forbidden to paint the inside of the appliance. No priming required.

**VOLUME:  
400 ml**



## BIODUR FOREST MARKING SPRAY



### Application

Used by professionals, special fluorescent paint for marking the forest, inscriptions, numbering of trees, ground, stones and mineral soils.

### Advantages

A special self-cleaning valve «360°» allows to apply the paint horizontally and vertically and at any angle for convenient work. The paint is sprayed from the can completely. After the end of work there is no need to turn over and purge out the can

### Chemical base

Acrylic enamel

13.75 €



Pink



Yellow



Orange



Red



Green

### Surfaces

forest marking, sorting and processing of timber; for marking on power lines and pipelines, in geodesy and topography, for marking of hiking trails and routes, for marking sports grounds, in construction and landscape design, in quarries and mines.

**VOLUME:**  
**500 ml**

## BIODUR CONSTRUCTION MARKING SPRAY



### Application

Used for signal marking on a construction fields, during repairing and road construction, heavy machinery installation, tunnels and quarries. Perfect for geodesic and archeology.

### Advantages

Fluorescent marking highly visible even in a low light places. Resistant to weather and temperatures impact. Has perfect adhesion to wet surfaces.

### Chemical base

Acrylic resin

13.75 €



Pink



Yellow



Red

### Surfaces

Asphalt, concrete, bricks, clay, grass, stones, wood, metal, plaster, etc.

### Peculiarities

360 valve allows to apply marking at any angle to any surface, easy to work,

**VOLUME:**  
**500 ml**

## BIODUR ACRYLIC ENAMEL



### Application

Used for refurbishing, painting, restoration of car paintwork. For indoor and outdoor use.

### Advantages

It has high resistance to ultraviolet, temperature changes and mechanical impact.

### Chemical base

Automotive acrylic enamel.

### Spreading capacity

2,3-3,0 m<sup>2</sup>.

10.60 €

### Drying time

7-10 min. at a t +25°C.



RAL 9005  
Black gloss



RAL 9005  
Black matt



RAL 9010  
White

### Surfaces

Car, motorcycle, scooter, bicycle, snowmobiles, agricultural equipment, water transport (above waterline)

### Peculiarities

Can be used to paint any metal, glass, wood, concrete and other surfaces.

**VOLUME:**  
**500 ml**

## BIODUR ACRYLIC LACQUER



### Application

Used for refurbishing , painting, restoration of car paintwork. For indoor and outdoor use.

### Advantages

Increase final paintwork durability at 25%, enhances the depth of any color. It does not fade in the sun, does not lose its luster. Provides super gloss and protects from the abrasive action of sand, stone blows, the carrozion effect of water and salt solutions.

### Chemical base

Automotive acrylic lacquer.

### Spreading capacity

2,0-2,5 m<sup>2</sup>.

### Drying time

7-10 min. at a t +25°C.

10.60 €



Gloss

### Surfaces

Car, motorcycle, scooter, bicycle, snowmobiles, agricultural equipment and other automotive objects.

### Peculiarities

Can be used to paint any metal, glass, wood, concrete and other surfaces.

**VOLUME:  
500 ml**

## BIODUR ACRYLIC PRIMER



### Application

Used for the preparation and restoration of car paintwork. For indoor and outdoor use.

### Advantages

It has high resistance to temperature changes and mechanical impact. Protects metal from corrosion. Reduces paint consumption on 30%.

### Chemical base

Automotive acrylic primer.

### Spreading capacity

2,0-2,5 m<sup>2</sup>.

### Drying time

7-10 min. at a t +25°C.

10.60 €



Grey

### Surfaces

Car, motorcycle, scooter, bicycle, snowmobiles, agricultural equipment, water transport (above waterline)

### Peculiarities

Sanding possible in a 30 min. after priming.

**VOLUME:  
500 ml**

## BIODUR WHEEL PAINT



### Application

Used for refurbishing , painting, composite or steal rims restoration.

### Advantages

One can is enough for all 4 rims paintwork. High resistance to abrasive action of sand, stone blows, the carrozion effect of water and salt solutions. Makes super durable coating that contains metal pigment.

### Chemical base

Automotive acrylic enamel with metal pigment.

### Spreading capacity

2,5-3,0 m<sup>2</sup>.

### Drying time

7-10 min. at a t +25°C.

10.60 €



Silver

### Surfaces

Rims of any types for cars, buses, trucks, motorcycles, etc.

### Peculiarities

To obtain maximum gloss, it is recommended to apply a transparent acrylic lacquer 30 minutes after painting.

**VOLUME:  
500 ml**

## HOW IT'S MADE

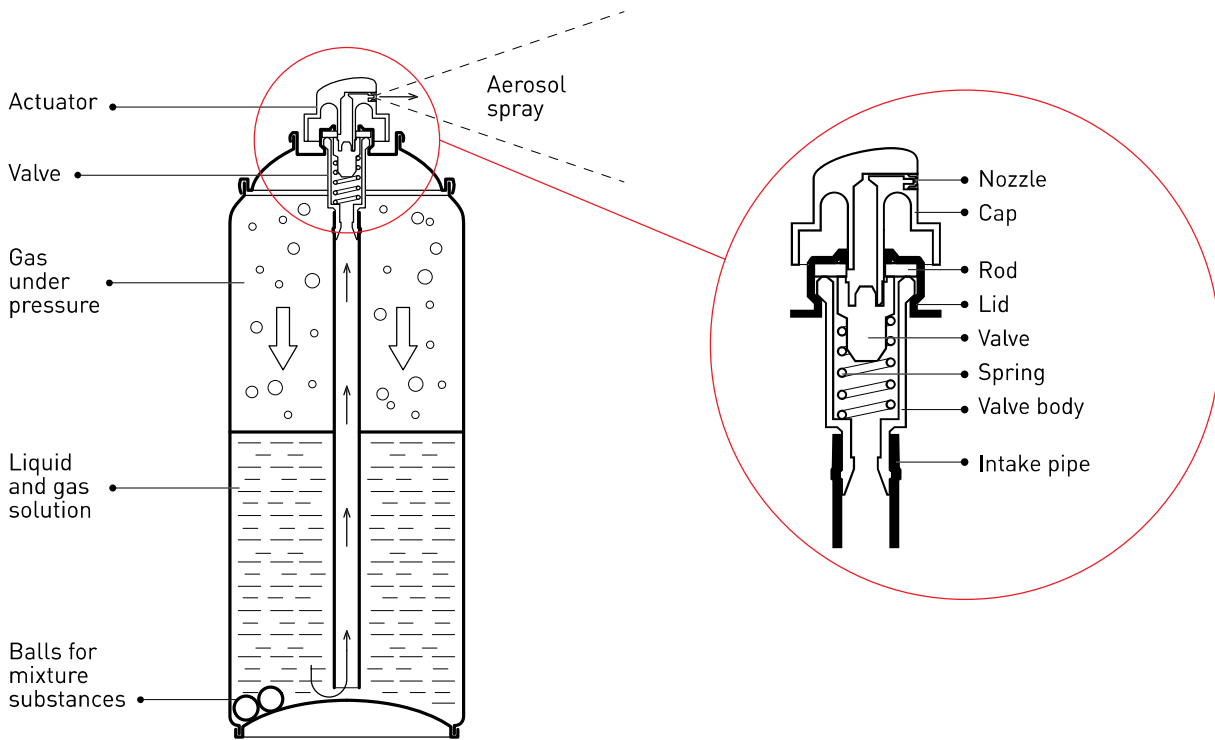









## SEQUENCE COATING MATERIALS

Temperature changes, weather and mechanical impact damages paintwork. Recommended coating sequence Primer-Enamel-Lacquer enhances durability by 3 times.

	New cover	Loss of brilliance	Change the color	The appearance of cracks and stratifications
<b>Lacquer</b>				
<b>Paint</b>				
<b>Primer</b>				
<b>Surface</b>				

<p><b>Primer</b> Smooths the surface, fill cavities and gaps, increase adhesion, reduces paint consumption on 30%, protecting the metal from corrosion.</p>	20 min	<p><b>Enamel</b> Creates a strong coat resistant to mechanic and weather exposure. Has high adhesion rate and increased covering capacity. Does not fade out in the sunlight. Colors correspond with European classification RAL.</p>	20 min	<p><b>Lacquer</b> Increase durability of the final surface at 20%. Enhances color depth. Does not fade out in the sunlight.</p>
---	--------	---	--------	---

## HOW TO USE SPRAY PAINT

<p>Prepare</p>  <p>the surface</p>	Prepare the surface: clean, degrease, apply primer.	<p>distance</p>  <p>25-30 cm</p>	Hold the can upright and apply thin layer on 25-30 cm distance.	<p>Clean</p>  <p>the valve</p>	Clean the valve, turn the can upside down and push the actuator till you see clean, noncolored gas.
<p>Shake</p>  <p>2-3 min</p>	Shake the can 2-3 min to mix the ingredients.	<p>time</p>  <p>3-5 min</p>	It's better to apply couple thin layers to reduce from drops.	<p>best</p>  <p>+15°C -30°C use</p>	+15 - +30°C is optimum temperature conditions for painting.
<p>Test</p>  <p>spray</p>	Try it on testing surface for checking.	<p>Application</p>  <p>method</p>	Apply 2-3 thin layers with 3-5 min interval between layers.	<p>Storage</p>  <p>conditions</p>	Store at house temperature, keep it away from open fire and heaters. Keep away from children. Do not store or use at a temperature +50°C.

## GUIDE TO PAINTING VARIOUS SURFACES

	Iron	Nonferrous metal	Wood	Glass	Brick	Plastic	Gypsum plasterboard	Concrete	Paper, cardboard	Ceramic	Sanitary ceramic	AGD
ENAMEL UNIVERSAL	✓	✓	✓	✓	✓	✓	✓	✓	✓	—	✓	—
LACQUER UNIVERSAL	✓	✓	✓	✓	✓	✓	✓	✓	✓	—	—	—
PRIMER UNIVERSAL	✓	✓	✓	✓	✓	✓	✓	✓	✓	—	✓	—
ZINC SPRAY	✓	✓	—	—	—	—	—	—	—	—	✓	—
ALUMINUM-ZINC ENAMEL	✓	✓	—	—	—	—	—	—	—	—	—	—
ALUMINUM NAMEL	✓	✓	✓	✓	✓	✓	✓	✓	—	—	—	—
ENAMEL SUPERCHROME	✓	✓	—	✓	—	✓	—	—	—	—	—	—
ENAMEL FLUORESCENT	✓	✓	✓	✓	✓	✓	✓	✓	✓	—	—	—
ENAMEL HEAT RESISTANT	✓	—	—	—	✓	—	—	—	—	—	—	—
ENAMEL FOR CERAMICS	—	—	—	—	—	—	—	—	—	✓	—	—
ENAMEL AGD	—	—	—	—	—	—	—	—	—	—	—	✓
FOREST MARKING SPRAY	—	—	✓	—	✓	—	—	✓	✓	—	—	—
CONSTRUCTION MARKING SPRAY	✓	✓	✓	✓	✓	✓	✓	✓	✓	—	—	—
ACRYLIC PRIMER	✓	—	✓	✓	✓	✓	✓	✓	✓	—	—	—
ACRYLIC LACQUER	✓	—	✓	✓	✓	✓	✓	✓	✓	—	—	—
ACRYLIC ENAMEL	✓	✓	✓	✓	✓	✓	✓	✓	✓	—	—	—
ACRYLIC WHEEL PAINT	✓	✓	✓	✓	✓	✓	✓	✓	✓	—	—	—

## RECOMMENDED PLACEMENT AT THE STAND

<b>SHELF №1</b>	LACQUER UNIVER Glossy	LACQUER UNIVER Mat	PRIMER UNIVER Grey	PRIMER UNIVER White	PRIMER UNIVER Black	ZINC SPRAY Zinc	ENAMEL HEAT RESIST Black	ENAMEL HEAT RESIST Silver
<b>SHELF №2</b>	ENAMEL UNIVER 9005 Glossy	ENAMEL UNIVER 9005 Glossy	ENAMEL UNIVER 9005 Mat	ENAMEL UNIVER 9005 Mat	ENAMEL UNIVER 9006 Silver	ENAMEL UNIVER 9003 Snow white	ENAMEL UNIVER 9010 Gloss	ENAMEL UNIVER 9010 Mat
<b>SHELF №3</b>	ENAMEL UNIVER 1001	ENAMEL UNIVER 1023	ENAMEL UNIVER 2004	ENAMEL UNIVER 3020	ENAMEL UNIVER 3002	ENAMEL UNIVER 3011	ENAMEL UNIVER 5015	ENAMEL UNIVER 5002
<b>SHELF №4</b>	ENAMEL UNIVER 6018	ENAMEL UNIVER 6029	ENAMEL UNIVER 6005	ENAMEL UNIVER 7024	ENAMEL UNIVER 7046	ENAMEL UNIVER 7035	ENAMEL UNIVER 8017	ENAMEL UNIVER 5010
<b>SHELF №5</b>	ENAMEL CERAMIC White	ENAMEL AGD White	ENAMEL FLUOR 1026	ENAMEL FLUOR 3024	ENAMEL UNIVER Bronze	ENAMEL UNIVER Antique gold	SUPER CHROME Silver	SUPER CHROME Gold



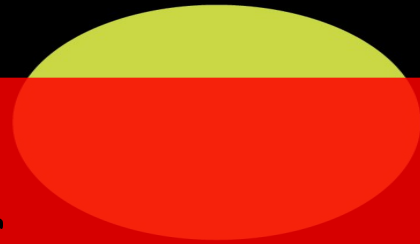
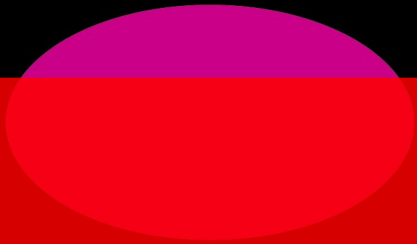
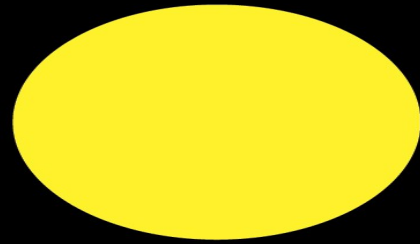
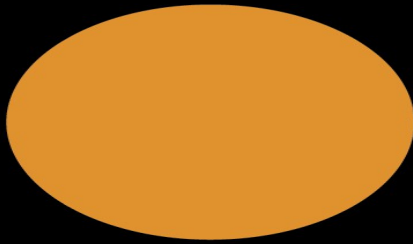
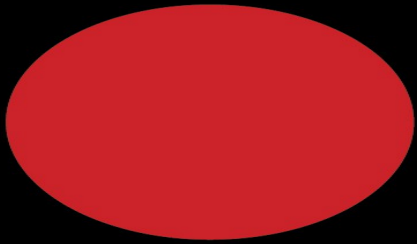

**BIODUR ACRYLIC**

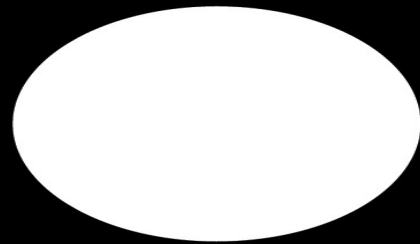
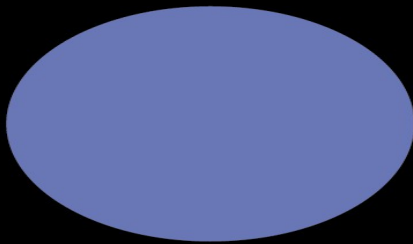
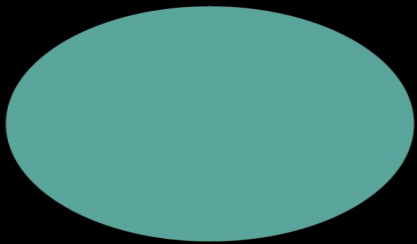
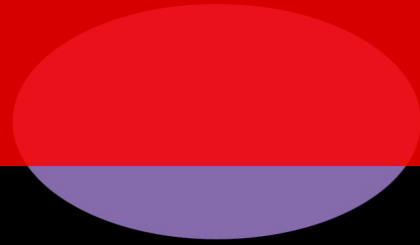
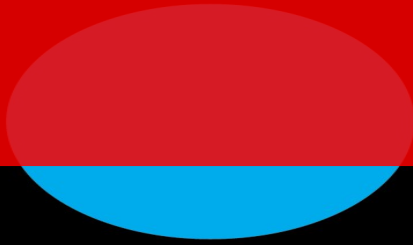
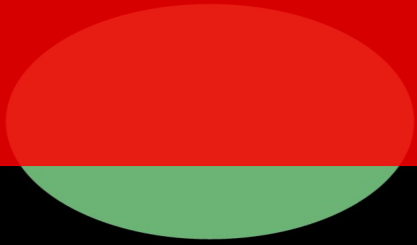





**ACRYLIC ENAMEL**  
400 ml

Prepare the surface	Shake 2-3 min	Distance 25-30 cm	Time 3-5 min	Clean up
Rust and weathering protection	In/out	Coverage 1,5-2,0 m <sup>2</sup>	Quick-drying	+15°C +30°C Best use

Used for painting metal, wood, stone, concret, plaster-cast, glass and some of plastic surfaces.



**ACRYLIC PRIMER**  
400 ml

Prepare the surface	Shake 2-3 min	Distance 25-30 cm	Time 3-5 min	Clean up
Excellent adhesive properties	In/out	Coverage 1,3-1,7 m <sup>2</sup>	Quick-drying	+15°C +30°C Best use

Designed to be used in treating different types of surfaces before painting, feal cavities and improving adhesion of enamels.



**ACRYLIC LACQUER**  
400 ml

Prepare the surface	Shake 2-3 min	Distance 25-30 cm	Time 3-5 min	Clean up
NO yellowing effect	In/out	Coverage 1,0-1,5 m <sup>2</sup>	Quick-drying	+15°C +30°C Best use

Used for protection painted surfaces from mechanical and weather impact. Can be used as independed coating.

**100% ACRYLIC<sup>1</sup>**

- ✓ Super-gloss
- ✓ Maximum coverage capacity
- ✓ Low paint costs
- ✓ UV light resistant

10.60 €

<sup>1</sup> It is intended to use acrylic resin as a sole binder without the addition of an alkyd resin.

## ACRYLIC ENAMEL 400 ml

16 RAL colours

- Coverage capacity: 1,5-2,0 m<sup>2</sup>
- Drying time (depends on a temperature and thiknes of layer): 10-15 minutes
- Recomend usage temperature: from +15 to +30 degrees of Celsius



RAL 1001  
BEIGE



RAL 1023  
YELLOW



RAL 3000  
FLAME RED



RAL 3020  
RED



RAL 2004  
ORANGE



RAL 5002  
BLUE



RAL 5015  
LIGHT BLUE



RAL 6005  
DARK GREEN



RAL 6029  
GREEN



RAL 7046  
GREY



RAL 8017  
DARK BROWN



RAL 9006  
SILVER



RAL 9005  
BLACK



RAL 9005  
BLACK MATT



RAL 9010  
WHITE



RAL 9010  
WHITE MATT

## ACRYLIC PRIMER 400 ml



GREY

Coverage capacity: 1,3-1,7 m<sup>2</sup>  
Drying time (depends on a temperature and thiknes of layer): 10-15 minutes  
Recomended usage temperature: from +15 to +30 degrees of Celsius

## ACRYLIC LACQUER 400 ml



GLOSS

Coverage capacity: 1-1,5 m<sup>2</sup>  
Drying time (depends on a temperature and thiknes of layer): 10-15 minutes  
Recomended usage temperature: from +15 to +30 degrees of Celsius

10.60 €

## **BASIC CHARACTERISTICS**

- High quality acrylic resins based.
- Enamel, Primer, Lacquer has high level of adhesion to various surfaces.
- Extremely high level of gloss and elastic characteristics.
- Resistant to weather and mechanic impact.
- High coverage capacity permit economy use of paint, primer or lacquer to apply the coating on a surface.
- No “yellowing” white colour RAL 9010 (gloss and matt).
- Gloss lacquer increases deep colour of painted surface and can be used as independent coating. Lacquer has high “yellowing” resistance.
- Well balanced valve and button combination. Easy to use, prevents from most of application mistakes.
- Shelf-life: 5 years.
- Packaging – 12 can's in 1 box.

	A	B	C	J
1	№	Product's name	Barcode	
2		<b>Universal Enamel BIODUR, 400 ml</b>		price
3	<b>B3769</b>	1001 Beige 400 ml, aerosol	4820155683769	7,4
4	<b>B3776</b>	1015 Ivory 400 ml, aerosol	4820155683776	7,4
5	<b>B3783</b>	1016 Lemon-yellow 400 ml, aerosol	4820155683783	7,4
6	<b>B3790</b>	1023 Yellow 400 ml, aerosol	4820155683790	7,4
7	<b>B5398</b>	1028 Yellow melon 400 ml, aerosol	4820155685398	7,4
8	<b>B3806</b>	1036 Dark Gold 400 ml, aerosol	4820155683806	7,4
9	<b>B3713</b>	2004 Orange 400 ml, aerosol	4820155683813	7,4
10	<b>B5350</b>	3000 Flame Red 400 ml, aerosol	4820155685350	7,4
11	<b>B3820</b>	3002 Dark Red 400 ml, aerosol	4820155683820	7,4
12	<b>B3837</b>	3005 Dark Cherry 400 ml, aerosol	4820155683837	7,4
13	<b>B3844</b>	3011 Cherry 400 ml, aerosol	4820155683844	7,4
14	<b>B3851</b>	3020 Red 400 ml, aerosol	4820155683851	7,4
15	<b>B3868</b>	3050 Light Gold 400 ml, aerosol	4820155683868	7,4
16	<b>B3875</b>	4003 Pink 400 ml, aerosol	4820155683875	7,4
17	<b>B3882</b>	4005 Violet 400 ml, aerosol	4820155683882	7,4
18	<b>B3899</b>	5002 Blue 400 ml, aerosol	4820155683899	7,4
19	<b>B3912</b>	5010 Regular blue 400 ml, aerosol	4820155683912	7,4
20	<b>B3929</b>	5015 Light blue 400 ml, aerosol	4820155683929	7,4
21	<b>B3936</b>	5021 Sea Wave 400 ml, aerosol	4820155683936	7,4
22	<b>B3943</b>	5022 Dark Blue 400 ml, aerosol	4820155683943	7,4
23	<b>B3950</b>	6005 Dark Green 400 ml, aerosol	4820155683950	7,4
24	<b>B3967</b>	6006 Khaki olive 400 ml aerosol	4820155683967	7,4
25	<b>B3974</b>	6010 Light Green 400 ml, aerosol	4820155683974	7,4
26	<b>B3981</b>	6018 Green Lettuce 400ml aerosol	4820155683981	7,4
27	<b>B3998</b>	6029 Green 400 ml, aerosol	4820155683998	7,4
28	<b>B7330</b>	7016 Grey anthracite Matt 400 ml, aerosol	4820155687330	7,4
29	<b>B5381</b>	7016 Grey anthracite 400 ml, aerosol	4820155685381	7,4
30	<b>B4001</b>	7024 Dark Gray 400 ml, aerosol	4820155684001	7,4
31	<b>B4018</b>	7035 Light Gray 400 ml, aerosol	4820155684018	7,4
32	<b>B4025</b>	7046 Gray 400 ml, aerosol.	4820155684025	7,4
33	<b>B4032</b>	8011 Brown 400 ml, aerosol	4820155684032	7,4
34	<b>B7347</b>	8017 Dark Brown Matt 400 ml, aerosol	4820155687347	7,4
35	<b>B4049</b>	8017 Dark Brown 400 ml, aerosol	4820155684049	7,4
36	<b>B4056</b>	9003 Snow White 400 ml, aerosol	4820155684056	7,4
37	<b>B4063</b>	9005 Black gloss 400 ml, aerosol	4820155684063	7,4
38	<b>B7842</b>	9005 Black satin 400 ml, aerosol	4820155687842	7,4
39	<b>B4070</b>	9005 Black matt 400 ml, aerosol	4820155684070	7,4
40	<b>B4087</b>	9006 Silver 400 ml, aerosol	4820155684087	7,4
41	<b>B4094</b>	9010 White gloss 400 ml, aerosol	4820155684094	7,4
42	<b>B7835</b>	9010 White satin 400 ml, aerosol	4820155687835	7,4
43	<b>B4100</b>	9010 White matt 400 ml, aerosol	4820155684100	7,4
44	<b>B4117</b>	9022 Dark silver 400 ml, aerosol	4820155684117	7,4
45	<b>B4124</b>	Bronze 400 ml, aerosol	4820155684124	7,4
46	<b>B4148</b>	Copper 400 ml, aerosol	4820155684148	7,4
47	<b>B4131</b>	Antique Gold 400 ml, aerosol	4820155684131	7,4
48	<b>B6753</b>	Gold 24 carat 400 ml, aerosol	4820155686753	7,4
49		<b>Lacquer Lakiery uniwersalne</b>		
50	<b>B4155</b>	Lacquer gloss 400 ml, aerosol	4820155684155	7,4
51	<b>B4162</b>	Lacquer matt 400 ml, aerosol	4820155684162	7,4
52		<b>Primer Środki gruntujące</b>		
53	<b>B4179</b>	Primer White 400 ml, aerosol	4820155684179	7,4
54	<b>B4186</b>	Primer Gray 400 ml, aerosol	4820155684186	7,4
55	<b>B4193</b>	Primer Red 400 ml, aerosol	4820155684193	7,4
56	<b>B4209</b>	Primer Black 400 ml, aerosol	4820155684209	7,4

	A	B	C	J
57		<b>Heat Resistant Enamel Emalie odporne na</b>		
58	<b>B4292</b>	White Heat Resistant 400 ml, aerosol	4820155684292	<b>11,25</b>
59	<b>B4353</b>	Silver Heat Resistant 400 ml, aerosol	4820155684353	<b>11,25</b>
60	<b>B4360</b>	Red Heat Resistant 400 ml, aerosol	4820155684360	<b>11,25</b>
61	<b>B4377</b>	Black Heat Resistant 400 ml, aerosol	4820155684377	<b>11,25</b>
62	<b>B4315</b>	Gold Heat Resistant 400 ml, aerosol	4820155684315	<b>11,25</b>
63		<b>Chrome Enamel Emalie "Chrome effect"</b>		
64	<b>B4414</b>	Chrom Gold 400 ml, aerosol	4820155684414	<b>11,40</b>
65	<b>B4438</b>	Chrom Silver 400 ml, aerosol	4820155684438	<b>11,40</b>
66		<b>Fluorescent Enamel Emalie fluorescencyjne</b>		
67	<b>B4445</b>	0096 Pink Fluorescent 400 ml, aerosol	4820155684445	<b>12,69</b>
68	<b>B4452</b>	1026 Yellow Fluorescent 400 ml, aerosol	4820155684452	<b>12,69</b>
69	<b>B4469</b>	3024 Orange Fluorescent 400 ml, aerosol	4820155684469	<b>12,69</b>
70	<b>B4476</b>	3026 Red Fluorescent 400 ml, aerosol	4820155684476	<b>12,69</b>
71	<b>B4483</b>	5016 Blue Fluorescent 400 ml, aerosol	4820155684483	<b>12,69</b>
72	<b>B4490</b>	9015 Green Fluorescent 400 ml, aerosol	4820155684490	<b>12,69</b>
73		<b>Zink Spray Farba cynkowa</b>		
74	<b>B5367</b>	Zink Spray 400 ml, aerosol	4820155685367	<b>10,00</b>
75	<b>B6722</b>	Alu-zinc spray 400 ml, aerosol	4820155686722	<b>10,00</b>
76	<b>B6708</b>	Aluminium spray 400 ml, aerosol	4820155686708	<b>10,00</b>
77		<b>Restoration of household Emalia do renowacji</b>		
78	<b>B4391</b>	Restoration of household 400 ml	4820155684391	<b>8,13</b>
79		<b>Enamel Porcelain Emalia do ceramiki, 400 ml</b>		
80	<b>B4384</b>	Enamel Porcelain 400 ml, aerosol	4820155684384	<b>8,13</b>
81		<b>Forest marking spray Farba do znakowania</b>		
82	<b>B6081</b>	Pink Fluorescent 500 ml, aerosol	4820155686081	<b>13,75</b>
83	<b>B6098</b>	Yellow luorescent 500 ml, aerosol	4820155686098	<b>13,75</b>
84	<b>B6067</b>	Orange Fluorescent 500 ml, aerosol	4820155686067	<b>13,75</b>
85	<b>B6050</b>	Red Fluorescent 500 ml, aerosol	4820155686050	<b>13,75</b>
86	<b>B6074</b>	Green Fluorescent 500 ml, aerosol	4820155686074	<b>13,75</b>
87		<b>Construction marker spray Marker budowlany w</b>		
88	<b>B7514</b>	Construction marker Red 500 ml, aerosol	4820155687514	<b>13,75</b>
89	<b>B7521</b>	Construction marker Orange 500 ml, aerosol	4820155687521	<b>13,75</b>
90	<b>B7538</b>	Construction marker Yellow 500 ml, aerosol	4820155687538	<b>13,75</b>
91		<b>Acrylic series 500 ml Automotive paint for cars</b>		
92		(= alternative to Motip 500ml for auto)		
93	<b>B6616</b>	RAL 9010 ACRYLIC WHITE GLOSS 500 ml	4820155686616	<b>10,60</b>
94	<b>B6630</b>	RAL 9005 ACRYLIC BLACK GLOSS 500 ml	4820155686630	<b>10,60</b>
95	<b>B6623</b>	RAL 9005 ACRYLIC BLACK MATT 500 ml	4820155686623	<b>10,60</b>
96	<b>B6647</b>	ACRYLIC WHEEL PAINT SILVER 500 ml	4820155686647	<b>10,60</b>
97	<b>B6654</b>	ACRYLIC LACQUER GLOSS 500 ml	4820155686654	<b>10,60</b>
98	<b>B6661</b>	ACRYLIC PRIMER GREY 500 ml	4820155686661	<b>10,60</b>
99		<b>Industrial paints</b>		
100	<b>B5206</b>	Wax Anti-Corrosion Coating PiTon in aerosol package 500 ml(1x6)	4820155685206	<b>8,45</b>
101	<b>B5244</b>	Anti Gravel Coating PiTon in aerosol package 500 ml (1x6)	4820155685244	<b>8,78</b>
102	<b>B4810</b>	Silicone Spray PiTon in aerosol package 150ml(1x20)	4820155684810	<b>4,68</b>
103	<b>B4827</b>	Silicone Spray PiTon in aerosol package 320ml(1x20)	4820155684827	<b>6,85</b>
104	<b>B5251</b>	Multi Purpose Lubricant PiTon aerosol package 150ml(1x20)	4820155685251	<b>4,68</b>
105	<b>B5268</b>	Multi Purpose Lubricant PiTon in aerosol package 400ml(1x12)	4820155685268	<b>6,85</b>
106	<b>B5305</b>	Liquid wrench PiTon in aerosol package 150ml(1x20)	4820155685305	<b>4,68</b>
107	<b>B5299</b>	Liquid wrench PiTon in aerosol package 400ml(1x12)	4820155685299	<b>6,85</b>
108	<b>B5312</b>	Chain lube spray PiTon in aerosol package 150ml(1x20)	4820155685312	<b>5,98</b>
109	<b>B5688</b>	Chain lube spray PiTon in aerosol package 400ml(1x12)	4820155685688	<b>10,45</b>
110		<b>BIODUR Acrylic line 400 ml universal purposes</b>		
111	<b>B7606</b>	1001 Beige BIODUR ACRYLIC, 400 ml.	4820155687606	<b>10,60</b>
112	<b>B7613</b>	1023 Yellow BIODUR ACRYLIC, 400 ml.	4820155687613	<b>10,60</b>



	A	B	C	J
113	<b>B7637</b>	2004 Orange BIODUR ACRYLIC, 400 ml.	4820155687637	10,60
114	<b>B7620</b>	3000 Flame Red BIODUR ACRYLIC, 400 ml.	4820155687620	10,60
115	<b>B7590</b>	3020 Red BIODUR ACRYLIC, 400 ml.	4820155687590	10,60
116	<b>B7644</b>	5002 Blue BIODUR ACRYLIC, 400 ml.	4820155687644	10,60
117	<b>B7651</b>	5015 Light blue BIODUR ACRYLIC, 400 ml.	4820155687651	10,60
118	<b>B7668</b>	6005 Dark Green BIODUR ACRYLIC, 400 ml.	4820155687668	10,60
119	<b>B7675</b>	6029 Green BIODUR ACRYLIC, 400 ml.	4820155687675	10,60
120	<b>B7682</b>	7046 Gray BIODUR ACRYLIC, 400 ml.	4820155687682	10,60
121	<b>B7699</b>	8017 Dark Brown, BIODUR ACRYLIC, 400 ml.	4820155687699	10,60
122	<b>B7576</b>	9005 Black gloss , BIODUR ACRYLIC, 400 ml.	4820155687576	10,60
123	<b>B7569</b>	9005 Black matt, BIODUR ACRYLIC, 400 ml.	4820155687569	10,60
124	<b>B7583</b>	9006 Silver, BIODUR ACRYLIC, 400 ml.	4820155687583	10,60
125	<b>B7552</b>	9010 White gloss, BIODUR ACRYLIC, 400 ml.	4820155687552	10,60
126	<b>B7545</b>	9010 White matt, BIODUR ACRYLIC, 400 ml.	4820155687545	10,60
127	<b>B7705</b>	Primer Gray BIODUR ACRYLIC, 400 ml.	4820155687705	10,60
128	<b>B7712</b>	Lacquer gloss, BIODUR ACRYLIC, 400 ml.	4820155687712	10,60
129		<b>Plastic Primer 400ml.</b>		
130	<b>B1277</b>	Plastic Primer 400ml neutral color silver	4823112401277	10,60
131				
132				
133				
134				
135				
136				
137				
138				
139				
140				
141				
142				
143				
144				
145				
146				
147				
148				
149				
150				
151				
152				
153				
154				
155				
156				
157				
158				
159				
160				
161				
162				
163				
164				
165				
166				
167				
168				
169				
170				
171				
172				



# CELLFAST



				<->	#	€
10-100		Set tuinslang 1/2" , snelstop-aansluiting, snelkoppeling, 26,5 mm vrouwelijke kraanneus Kit tuyau d'arrosage, raccord rapide - stop, raccord rapide, nez de robinet femelle 26,5 mm	12,5 mm	20 m	1	30,18
10-101		Set tuinslang 1/2" , snelstop-aansluiting, snelkoppeling, 26,5 mm vrouwelijke kraanneus Kit tuyau d'arrosage, raccord rapide - stop, raccord rapide, nez de robinet femelle 26,5 mm	12,5 mm	15 m	1	24,57





				<->	#	€
10-004		Tuinslang 1/2" ECONOMIC Tuyau d'arrosage ECONOMIC	12,5 mm	15 m	1	18,52
10-002		Tuinslang 1/2" ECONOMIC Tuyau d'arrosage ECONOMIC	12,5 mm	30 m	1	35,80
10-003		Tuinslang 1/2" ECONOMIC Tuyau d'arrosage ECONOMIC	12,5 mm	50 m	1	59,34





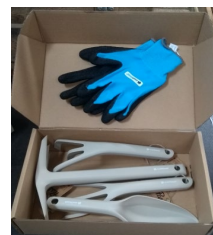























				<->	#	€
10-064		Tuinslang 1/2 " QUATTRO, 4-laags, licht en duurzaam Tuyau d'arrosage QUATTRO, 4 couches, léger et durable	12,5 mm	15 m	1	21,81

# CELLFAST



			#	€	
40-050		Kit Onderhoudsset PASTEL : 4 pcs + 1 paar handschoenen Set d'outils de soin PASTEL : 4 pcs + gants inclusif	3	36,45	doos/boîte



				#	€
10-900DB-eco	-	Display BOX ECONOMIC - bevat het basisassortiment van producten uit het ECONOMIC gamma - 420 producten Présentoir BOX ECONOMIC - contient la gamme de base des produits du système d'eau ECONOMIC - 420 produits		1	655,00
			# Inhoud/ contenu display:	# bulk/en vrac:	
54-120		Snelkoppeling ECONOMIC 12,5 en 15 mm Raccord rapide stop ECONOMIC 12,5 et 15 mm		30	1,84
54-125		Snelkoppeling ECONOMIC 19 mm Raccord rapide stop ECONOMIC 19 mm		30	2,32
54-130		Snelkoppeling ECONOMIC 12,5 en 15 mm Raccord rapide ECONOMIC 12,5 et 15 mm		30	1,51
54-135		Snelkoppeling ECONOMIC 19 mm Raccord rapide ECONOMIC 19 mm		30	2,05
54-100		Reparatiestuk ECONOMIC 12,5 en 15 mm Réparateur ECONOMIC 12,5 et 15 mm		40	1,24
54-105		Reparatiestuk ECONOMIC 19 mm Réparateur ECONOMIC 19 mm		20	1,84
54-150		Vrouwelijke kraanneus ECONOMIC 1/2" Nez de robinet femelle ECONOMIC 1/2"		60	0,70
54-155		Vrouwelijke kraanneus ECONOMIC 3/4" Nez de robinet femelle ECONOMIC 3/4"		60	0,81
54-160		Vrouwelijke kraanneus ECONOMIC 1" Nez de robinet femelle ECONOMIC 1"		40	0,92
54-140		Dubbele koppeling ECONOMIC Raccord double ECONOMIC		40	0,92
54-300		Slangstuk ECONOMIC Arroseur simple ECONOMIC		20	2,05
52-425		Handsproeier ECONOMIC Pistolet d'arrosage ECONOMIC		10	6,10
52-420		Handsproeier rond ECONOMIC Pistolet d'arrosage - pomme ECONOMIC		10	7,07

# CELLFAST



53-210		Vrouwelijke univ. kraanneus ERGO 1/2"-3/4"-1" Nez de robinet univ. femelle ERGO	21 - 26,5 - 33,3 mm	#	€	blister
				8	8,26	



50-210	5901828856129	Vrouwelijke kraanneus BASIC 1/2" Nez de robinet femelle BASIC	21 mm	#	€	blister
				5	1,62	
50-215	5901828856136	Vrouwelijke kraanneus BASIC 3/4" Nez de robinet femelle BASIC 3/4"	26,5mm	5	1,89	blister



50-320		Handsproeier BASIC Pistolet d'arrosage BASIC		#	€	blister
				5	9,07	



# CELLFAST



50-130		Snelkoppeling 1/2"-5/8" BASIC Raccord rapide BASIC	12,5 - 15 mm	# 5	€ 2,48	blister
--------	---	---	--------------	--------	-----------	---------



50-300		Slangstuk BASIC Lance d'arrosage BASIC		# 5	€ 3,67	blister
--------	---	---	--	--------	-----------	---------



50-610

50-105	5901828856020	Reparatiestuk 3/4" BASIC Réparateur BASIC	19 mm	# 30	€ 2,59	blister
50-610	5901828857751	Reparatiestuk 1/2" - 5/8" - 1" Réparateur IDEAL 1/2" - 5/8" - 1"	(12,5-15/18mm)	# 5	€ 3,56	blister
50-100	5901828856013	Reparatiestuk 1/2" BASIC Réparateur BASIC	12,50 mm	# 5	€ 2,32	blister

**NEW**



50-500		Verstelbare besproeiingsset 1/2"-5/8" BASIC, 12,5-15mm Réglable kit d'arrosage 1/2"-5/8" BASIC, 12,5-15mm		# 10	€ 9,99	blister
--------	--	--	--	---------	-----------	---------



			#	€		
50-205	5901828856112	3-way connector BASIC 3/4" 1/2" - 5/8"	5	2,27		blister



			#	€		
50-200	5901828856105	extension connector BASIC 3/4" 1/2" - 5/8"	5	1,79		blister



			#	€		
52-305	5907553508104	extension connector BASIC	1	23,00		blister

# CELLFAST



prevents the hose from kinking at the tap  
360 ° horizontal and 180 ° vertical rotation  
suitable for tap G1 / 2 " , G3 / 4" and G1 "

			#	€	
52-250	5907512602911	Multi-purpose angle connector + female thread G1/2" - G3/4" - G1"	1	9,18	bulk/label



allows you to easily control the use of water in the garden, helping to save it  
equipped with a quick coupler, mounted to the water connection  
large, easy-to-read display and buttons enable selection of appropriate settings  
working pressure: 0.5-6 bar  
flow measurement range: 1-29 l / min,  
flow measurement up to 999.9 gallons / liters  
measurement tolerance: ± 10%  
maximum water temperature: 40 ° C  
3V CR2032 battery included  
CE marking

			#	€	
52-096	5907553509941	watervbruik meter - compteur de consommation d'eau	1	49,52	blister

# CELLFAST



			#	€	
55-600	5901828856495	chariot dévidoir discover	1	117,09	bulk



			#	€	
55-620	5901828858215	slangenwagen 20m tuinslang / chariot 20m tuyaux 1/2"	1	210,67	bulk
55-625	5901828856716	chariot 25m tuyaux 1/2"	1	243,32	bulk
55-630	5901828859168	chariot 30m tuyaux 1/2"	1	256,55	bulk



55-410



55-993

			#	€	
55-993	5901828855993	support mural de tuyau	1	6,96	bulk
55-410	5907553509774	enrouleur de tuyau automatique 1/2" 22M	1	403,48	bulk

Kruiwagen 100 L gegalvaniseerd - Brouette galvanisée 100L



IS005922M	100L	Kruiwagen - brouette 100L + RUDP3M (ROUE + PNEU) zwart /noir monté	€ 140,00
IS005923M	100L	Kruiwagen brouette 100L+RUDS3M (ROUE+PNEU <b>PU</b> )blauw/blue monté	€ 160,00



RUDP3M		Pneumatic wheel 14" axe 170mm	€ 38,50
--------	--	-------------------------------	---------



RUDSE3M		Volle band PU - Polyuretanic wheel 14" PU axe 170mm	€ 54,00
---------	--	---	---------



F280400		Handvaten - poignée de brouette - 140 mm- Ø 30 mm/ 2 pcs	€ 3,50
---------	--	--	--------



F005922M	80L	Kruiwagen - brouette 80L + RUDP3M (ROUE + PNEU) monté	€ 127,00
F005923M	80L	Kruiwagen - brouette 80L + RUDS3M (ROUE + PNEU <b>PU</b> ) monté	€ 140,00



6L



12L



1148805 | Watering-Can 6 Lt Assort Classic  
BARCODE: 8435421817029

€ 14,00

1150105 | Watering-Can 12 Lt Assort Classic  
BARCODE: 8435421847170

€ 17,50



2 L



5L



10 L

I013000	10pcs	GIETER 2 L	4008189800233	€ 3,99
I010297	10pcs	GIETER 5 L	8718692626676	€ 8,61
I010091	10pcs	GIETER 10L	8718692624818	€ 11,07

STEEKWAGEN 90 KG -

DIABLE PLIABLE 90 KG



poids = 7kg

HML-902	STEEKWAGEN 90 KG - DIABLE PLIABLE 90 KG	€ 92,00
---------	---	---------



poids = 8 kg

HPL-WMN01	STEEKWAGEN BLAUW - DIABLE BLEU 200 kg	€ 98,20
-----------	---------------------------------------	---------

## MUGGENGAAS - MOUSTIQUAIRE





			<->	#	€
602810052285		Muggennet bed Moustiquaire de lit	220 cm h, diam 850 cm	1	33,80
F417336		Insectenscherm deuropening 100% polyester, inclusief velcro + magneten Moustiquaire de porte 100% polyester, incl. velcro + aimants	100 x 220 cm	1	16,20

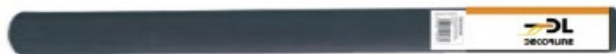

			<->	#	€
6098060100		Muggengaas op rol, glasvezel, grijs Moustiquaire en rouleau, en fibre, gris	60 cm x 30 m	1	72.66
6098080100		Muggengaas op rol, glasvezel, grijs Moustiquaire en rouleau, en fibre, gris	80 cm x 30 m	1	96.88
6098100100		Muggengaas op rol, glasvezel, grijs Moustiquaire en rouleau, en fibre, gris	100 cm x 30 m	1	121.10
F417110		Muggengaas op rol, glasvezel, grijs Moustiquaire en rouleau, en fibre, gris	100 cm x 50 m	1	164,70
6098120100		Muggengaas op rol, glasvezel, grijs Moustiquaire en rouleau, en fibre, gris	120 cm x 30 m	1	145.31
6098150100		Muggengaas op rol, glasvezel, grijs Moustiquaire en rouleau, en fibre, gris	150 cm x 30 m	1	181.64
6098180100		Muggengaas op rol, glasvezel, grijs Moustiquaire en rouleau, en fibre, gris	180 cm x 145 m	1	1425,75
6098240100		Muggengaas op rol, glasvezel, grijs Moustiquaire en rouleau, en fibre, gris	240 cm x 145 m	1	1900.00



			<->	#	€
602910		Minirol muggengaas, glasvezel, grijs Moustiquaire en rouleau mini, en fibre, gris	100 cm x 3 m	1	32,90
602911		Minirol muggengaas, glasvezel, grijs Moustiquaire en rouleau mini, en fibre, gris	150 cm x 3 m	1	42.15



			<->	#	€
6096120		Muggengaas op rol, aluminium, grijs Moustiquaire en rouleau, en aluminium, gris	120 cm x 30 m	1	16.50/mt
6097120		Muggengaas op rol, stainless steel inox, grijs Moustiquaire en rouleau, stainless steel inox, gris	120 cm x 30 m	1	47.50mt

## BRIEVENBUSSEN - BOITES POSTALES



21 X 7 X H 30

POPULAR

F048015		BRIEVENBUS - BOITE POSTAL MET KLEP - GROEN - VERT	€ 42,00
F048016		BRIEVENBUS - BOITE POSTAL COUVERCLE GRIJS - GRIS	€ 42,00
F048017		BRIEVENBUS - BOITE POSTAL COUVERCLE BEIGE -IVOORKLEUR	€ 42,00
F048018		BRIEVENBUS - BOITE POSTAL MET KLEP - WIT - BLANC	€ 42,00



22 X 9 X H 31

DOMUS

F048005		BRIEVENBUS - BOITE POSTAL GROEN - VERT	€ 52,00
F048006		BRIEVENBUS - BOITE POSTAL GRIJS-GRIS	€ 52,00
F048007		BRIEVENBUS - BOITE POSTAL BEIGE -IVOORKLEUR	€ 52,00

## VUILNISEMMERS - POUBELLES

<b>9 L</b>	<b>15 L</b>	<b>30 L</b>	<b>50 L</b>
			
24 x 18,5 x 39 0,36 kg 6 pcs / c	28,5 x 22,5 x 47 0,52 kg 6 pcs / c	34 x 27,5 x 58,5 0,88 kg 6 pcs / c	40 x 35 x 68,5 1,52 kg 6 pcs / c
<b>1156012</b> € 12,67	<b>1156112</b> € 17,14	<b>1182812</b> € 21,41	<b>1182912</b> € 36,42

## VUILNISZAKKEN - SACS POUBELLES



15 L = 15 pcs / verpakking  
60L = 10pcs / emballage  
120L = 10 pcs / verpakking

I008296	15L	Vuilniszakken met trekkoord -sacs poubelles lien coulissant bleu	50 pcs/c	€ 2,71
I008297	60L	Vuilniszakken met trekkoord -sacs poubelles lien coulissant bleu	50 pcs/c	€ 3,20
I008298	120L	Vuilniszakken met trekkoord -sacs poubelles lien coulissant gris	30 pcs/c	€ 4,59



## DROOGREK - SECHOIRS 100% ALU



L189 H94 B56

F419050	Aluminium droogrek GIMI	€ 64,20
	Séchoir en aluminium GIMI	

Afbeelding	Omschrijving	Bruto Prijs BTW excl. EAN
------------	--------------	---------------------------



I006752  
WD40 5 ltr + spray applicator  
WD40 5 ltr + spray applicator

€ 127.82  
per 1 pc



I009175  
WD40 330ml smart straw  
WD40 330ml smart straw

€ 14.76  
per 20 pcs



I009769  
WD40 240ml ( 200 ml + 20% free)  
WD40 240ml ( 200 ml + 20% free)

€ 8.81  
per 30 pcs



I011756  
WD40 150ml  
WD40 150ml

€ 7.33  
per 30 pcs



I011757  
WD40 BIKE ALL CONDITIONS LUBE 250 ML  
WD40 BIKE ALL CONDITIONS LUBE 250 ML

€ 22.14  
per 30 pcs



I012048  
WD40 200ml  
WD40 200ml







€ 0.0  
niet leverbaar - pas en stock



I012437  
WD-40 250ML  
WD-40 250ML

€ 9.30  
per 21 pcs



Afbeelding	Omschrijving	Bruto Prijs BTW excl. EAN
	<p>WD-40 I004621</p> <p>WD40 450ml smart straw</p>	<p>€ 19.58 per 24 pcs</p> 
	<p>I005652 WD40 80ml</p> <p>WD40 80ml</p>	<p>€ 6.15 per 12 pcs</p> 
	<p>I011755 WD-40 SPECIALIST SLOTSPRAY 100ML</p> <p>WD40 SPECIALIST LOCKSPRAY 100ML</p>	<p>€ 13.23 per 12 pcs</p> 



F041510	Varta Longlife display	204,50
10 blisters AA (10pcs/blister)+12 blisters AAA(10pcs/blister)		



F229059	AD BLUE 10 L contenu/inhoud	38,60
---------	-----------------------------	-------



F280386	60 kg capaciteit - aluminium	79,00
40x40xH90/100 cm - 5 pcs / display		

